

SUBDIVISION REGULATIONS

FOR INCORPORATED AND UNINCORPORATED
PENDLETON COUNTY, KENTUCKY

ADOPTED BY
THE PENDLETON COUNTY PLANNING COMMISSION

SUBDIVISION REGULATIONS
FOR INCORPORATED AND UNINCORPORATED
PENDLETON COUNTY, KENTUCKY

ADOPTED: November 24, 2003

BY THE PENDLETON COUNTY PLANNING COMMISSION

Prepared by:

NORTHERN KENTUCKY AREA PLANNING COMMISSION

PENDLETON COUNTY SUBDIVISION REGULATIONS

TABLE OF CONTENTS

	<u>PAGE</u>
ARTICLE I - APPLICATION AND AUTHORITY OF REGULATIONS	
SECTION 1.0 SHORT TITLE	1-1
SECTION 1.1 PURPOSE AND AUTHORITY	1-1
SECTION 1.2 TRANSFER OF LOTS	1-1
SECTION 1.3 GENERAL RESPONSIBILITIES	1-2
ARTICLE II - DEFINITIONS	
SECTION 2.0 WORDS AND PHRASES	2-1
ARTICLE III - SUBDIVISION PROCEDURE	
SECTION 3.0 PRELIMINARY INFORMATION	3-1
SECTION 3.1 SUBMISSION OF PRELIMINARY PLAT	3-1
SECTION 3.2 PROCESSING OF THE PRELIMINARY PLAT	3-1
SECTION 3.3 PLANNING COMMISSION ACTION	3-2
SECTION 3.4 SUBMISSION AND PROCESSING OF PRELIMINARY GRADING PLANS AND/OR EROSION AND SEDIMENTATION CONTROL PLANS	3-2
SECTION 3.5 SUBMISSION OF IMPROVEMENT DRAWINGS AND SPECIFICATIONS	3-3
SECTION 3.6 PROCESSING OF IMPROVEMENT DRAWINGS AND SPECIFICATIONS	3-3
SECTION 3.7 SUBMISSION OF THE FINAL PLAT	3-3
SECTION 3.8 PROCESSING OF THE FINAL PLAT AND WHERE APPLICABLE, THE IMPROVEMENT DRAWINGS AND SPECIFICATIONS	3-5
SECTION 3.9 PLANNING COMMISSION ACTION	3-5
SECTION 3.10 EFFECT OF APPROVAL	3-6
SECTION 3.11 DISPOSITION OF APPROVED FINAL PLAT	3-6
SECTION 3.12 ACCEPTANCE OF IMPROVEMENTS FOR MAINTENANCE AND/OR LAND OFFERED FOR	3-6
SECTION 3.13 SUBMISSION AND PROCESSING OF CONDOMINIUM PROPERTY REGIME PLATS IMPROVEMENT DRAWINGS	3-6
SECTION 3.14 SUBMISSION AND PROCESSING OF IDENTIFICATION PLATS	3-8
ARTICLE IV - PRELIMINARY PLAT REQUIREMENTS	
SECTION 4.0 SPECIFICATIONS FOR AND CONTENT OF THE PRELIMINARY PLAT	4-1
ARTICLE V - FINAL PLAT REQUIREMENTS INCLUDING IMPROVEMENT DRAWINGS AND SPECIFICATIONS	
SECTION 5.0 SPECIFICATIONS FOR AND CONTENT OF THE FINAL PLAT	5-1

SUBDIVISION REGULATIONS
TABLE OF CONTENTS
(CONTINUED)

	<u>PAGE</u>	
ARTICLE VI - DESIGN STANDARDS FOR THE LAYOUT OF SUBDIVISIONS		
SECTION 6.0	STREETS	6-1
SECTION 6.1	INTERSECTIONS	6-8
SECTION 6.2	EASEMENTS	6-9
SECTION 6.3	PHYSICAL CONSIDERATIONS	6-10
SECTION 6.4	FLOOD HAZARDS	6-10
SECTION 6.5	BLOCKS	6-12
SECTION 6.6	LOTS	6-13
SECTION 6.7	PEDESTRIAN WAYS	6-14
SECTION 6.8	PUBLIC SITES	6-14
ARTICLE VII - INFRASTRUCTURE IMPROVEMENTS		
SECTION 7.0	STORMWATER DRAINAGE SYSTEMS	7-1
SECTION 7.1	SANITARY SEWER SYSTEM	7-22
SECTION 7.2	WATER SYSTEM	7-23
SECTION 7.3	STREETS	7-25
SECTION 7.4	DRIVEWAY APPROACHES	7-28
SECTION 7.5	STREET SIGNS	7-29
SECTION 7.6	MONUMENTATION	7-29
SECTION 7.7	PLANS FOR FUTURE EXPANSION - EXTRA SIZE AND OFF-SITE IMPROVEMENTS	7-30
SECTION 7.8	PLANS REQUIRED FOR GRADING AND CONTROL OF EROSION AND SEDIMENTATION STREET LIGHTS	7-30
SECTION 7.9	CONSTRUCTION INSPECTIONS	7-31
SECTION 7.10	CONSTRUCTION RESPONSIBILITIES	7-32
SECTION 7.11	FINAL CLEANING UP	7-33
SECTION 7.12	AGREEMENTS AND GUARANTEES	7-33

SUBDIVISION REGULATIONS
TABLE OF CONTENTS
(CONTINUED)

	<u>PAGE</u>
ARTICLE VIII - ADMINISTRATION AND ENFORCEMENT	
SECTION 8.0 ADMINISTRATION	8-1
SECTION 8.1 FEES FOR PRELIMINARY AND FINAL PLATS; GRADING PLANS, IMPROVEMENT DRAWINGS AND SPECIFICATIONS; INSPECTIONS AND OTHER PLATS	8-1
SECTION 8.2 PAYMENT OF FEES	8-1
SECTION 8.3 FEES FOR INSPECTING IMPROVEMENTS AS PER APPROVED GRADING PLANS, IMPROVEMENT DRAWINGS AND SPECIFICATIONS, AND/OR FINAL PLATS	8-1
SECTION 8.4 FEES FOR RECORDING FINAL PLATS IN COUNTY	
SECTION 8.5 MODIFICATIONS	8-1
SECTION 8.6 ENFORCEMENT	8-2
SECTION 8.7 PENALTIES	8-2
SECTION 8.8 SEVERABILITY	8-2
SECTION 8.9 CONFLICT	8-2
ARTICLE IX - ADOPTION, AMENDMENT, AND EFFECTIVE DATE	
SECTION 9.0 PUBLIC HEARING	9-1
SECTION 9.1 EFFECTIVE DATE	9-1
AMENDMENTS	9-2

APPENDICES

	<u>PAGE</u>
APPENDIX "A" -- CEMENT CONCRETE FOR STREET, CURB AND GUTTER, SIDEWALK AND DRIVEWAY CONSTRUCTION	*
APPENDIX "B" -- ASPHALT CONCRETE PAVEMENT FOR STREET AND DRIVEWAY CONSTRUCTION	*
APPENDIX "C" -- STANDARD CONSTRUCTION DETAILS FOR STREETS, SIDEWALKS, DRIVEWAYS, EROSION CONTROL, AND STORM DRAINAGE SYSTEM	*

* See separate document entitled: "Standard Specifications for Details for Street and Drainage Construction".

LIST OF TABLES

<u>NUMBER</u>	<u>TITLE</u>	<u>PAGE</u>
1	STREET RIGHTS-OF-WAY WIDTH AND GRADE REQUIREMENTS	6-2
2a	SIGHT DISTANCES FOR VEHICLES EXITING FROM ACCESS POINTS ONTO ADJACENT ROADS	6-5
2b	LEFT TURN SIGHT DISTANCE FOR VEHICLES ENTERING ACCESS POINTS	6-5
2c	SIGHT DISTANCE REQUIREMENTS	6-6
3	IMPROVEMENT REQUIREMENTS BY TYPE OF STREET SERVING SUBDIVISIONS	7-35

SUBDIVISION REGULATIONS

TABLE OF CONTENTS

		<u>PAGE</u>
APPENDIX "A" - CEMENT CONCRETE FOR STREET, CURB AND GUTTER, SIDEWALK AND DRIVEWAY CONSTRUCTION		
ITEM 1.0	GRADING	A-1
ITEM 2.0	MATERIALS	A-6
ITEM 3.0	BATCHING	A-7
ITEM 4.0	MEASURING AIR CONTENT	A-9
ITEM 5.0	FORMS	A-9
ITEM 6.0	PLACING CONCRETE	A-9
ITEM 7.0	CONSOLIDATING AND FINISHING	A-10
ITEM 8.0	INTEGRAL CURB	A-11
ITEM 9.0	CURING	A-11
ITEM 10.0	PAVEMENT JOINTS	A-13
ITEM 11.0	TIE BARS	A-15
ITEM 12.0	JOINT SEALER	A-15
ITEM 13.0	STRUCTURES ENCOUNTERED IN THE PAVED AREA	A-15
ITEM 14.0	PROTECTION AND OPENING TO TRAFFIC	A-15
ITEM 15.0	CURB, GUTTER, SIDEWALK, AND DRIVEWAYS	A-16
ITEM 16.0	PAVEMENT THICKNESS	A-16
APPENDIX "B" - ASPHALT CONCRETE PAVEMENT FOR STREET AND DRIVEWAY CONSTRUCTION		
ITEM 1.0	GRADING	B-1
ITEM 2.0	PREPARATION OF EXISTING GRANULAR BASE COURSES FOR SURFACING	B-6
ITEM 3.0	ASPHALT PAVEMENT	B-6
ITEM 4.0	DESIGN OF ASPHALT PAVEMENT STRUCTURE	B-8
ITEM 5.0	ADJUSTING MANHOLE TOPS	B-9
ITEM 6.0	JOINT SEALING COMPOUND	B-9
APPENDIX "C" - STANDARD CONSTRUCTION DETAILS FOR STREETS, SIDEWALKS, DRIVEWAYS, EROSION CONTROL, AND STORM DRAINAGE SYSTEM		

LIST OF TABLES

<u>NUMBER</u>	<u>TITLE</u>	<u>PAGE</u>
A-1	MINIMUM PAVEMENT THICKNESS FOR STREETS - PORTLAND CEMENT CONCRETE	A-18
B-1	TABLE OF COMPOSITION LIMITS FOR BITUMINOUS CONCRETE	B-10
B-2	THICKNESS REQUIREMENTS FOR ASPHALT PAVED STREETS	B-11

LIST OF DETAILS

<u>TITLE</u>	<u>PAGE</u>
TYPICAL SECTIONS - COURTS, CUL-DE-SACS, LOCAL, SUBCOLLECTOR COLLECTOR STREETS; TYPICAL SHOULDER AND DITCH DETAIL	C-2,C-3
RESIDENTIAL DRIVEWAY AND APRON DETAILS	C-4
CATCH BASIN CURB INLETS	C-5
TYPICAL SECTION - SIDE DITCH DRAINAGE AT DRIVEWAY	C-6
TURN-AROUND DETAILS FOR DEAD-END STREETS	C-7
DETAIL OF TEMPORARY TURN-AROUND FOR FUTURE STREET EXTENSION	C-8
CURB AND GUTTER DETAILS	C-9
TYPICAL CONCRETE JOINTING PLAN	C-10
JOINT DETAILS	C-11
MANHOLE DETAIL IN CONCRETE PAVEMENT	C-12
TYPICAL WATER MAIN AND FIRE HYDRANT ASSEMBLY LOCATION FOR ALL STREETS	C-13
STANDARD MANHOLE	C-14
STANDARD DROP MANHOLE	C-15
CATCH BASIN - DETAILS	C-16
CATCH BASIN CASTINGS DETAILS - SINGLE	C-17
CATCH BASIN CASTINGS DETAILS - DOUBLE	C-18
RIGID PAVEMENT BLOCKOUT DETAIL	C-19
FLEXIBLE PAVEMENT BLOCKOUT DETAIL ALT. A	C-20
FLEXIBLE PAVEMENT BLOCKOUT DETAIL ALT. B	C-21
YARD DRAIN - DETAILS	C-22
UTILITY TRENCH BACKFILL AND BEDDING	C-23

CONCRETE HEADWALLS 12"-24" PIPE	C-24
CONCRETE HEADWALLS 12"-36" PIPE	C-25
ENCLOSURE GRATE FOR INLET HEADWALL	C-26
SLOPED AND FLARED BOX INLET-OUTLET	C-27
SLOPED BOX INLET OR OUTLET TYPE I	C-28
RIP-RAP APRON AND CUTOFF WALL	C-29
SILT CHECK	C-30
SILT TRAP - TYPE A	C-31
SILT TRAP - TYPE B	C-32
TYPICAL DETAILS FOR SEDIMENTATION BASIN	C-33
CROSS-SECTION OF PROPERLY INSTALLED STRAW BALE	C-34
PERFORATED PIPE UNDERDRAINS	C-35
TYPICAL INSTALLATION FOR SIDEWALK RAMPS	C-36

ARTICLE I
APPLICATION AND AUTHORITY OF REGULATIONS

REGULATIONS FOR ESTABLISHING SUBDIVISION PROCEDURES FOR THE SUBMISSION AND APPROVAL OF THE PRELIMINARY AND FINAL PLAT AND RECORDING OF FINAL PLATS; DESIGN STANDARDS AND PRINCIPLES FOR THE LAYOUT OF SUBDIVISIONS AND FOR THE SURVEYING AND PLATTING REQUIREMENTS THEREOF; REQUIRING THE INSTALLATION OF CERTAIN IMPROVEMENTS AND PROVIDING FOR THE NECESSARY CONSTRUCTION AGREEMENTS AND GUARANTEES THEREIN; PROVIDING FOR CERTAIN PRELIMINARY AND FINAL PLAT REQUIREMENTS; DEFINING CERTAIN TERMS USED HEREIN; PROVIDING FOR THE METHOD OF ADMINISTRATION AND ENFORCEMENT AND THE PENALTIES FOR VIOLATION THEREOF; PROVIDING FOR THE MEANS OF ADOPTION AND AMENDMENT; REPEALING ALL REGULATIONS, RESOLUTIONS, ORDERS, ORDINANCES, AND/OR CODES IN CONFLICT HEREWITH.

SECTION 1.0 SHORT TITLE: These regulations shall be known and may be cited as the "Subdivision Regulations" of Pendleton County, State of Kentucky.

SECTION 1.1 PURPOSE AND AUTHORITY:

- A. PURPOSE: These Subdivision Regulations as herein set forth, have been prepared in accordance with the adopted comprehensive plan for Pendleton County, to promote the public health, safety, and general welfare of the county; to provide for the proper arrangement of streets in relation to existing or proposed streets; to provide for adequate and convenient open spaces for vehicular and pedestrian traffic circulation, utilities, access of fire fighting apparatus, the avoidance of congestion of the population, and to facilitate the orderly and efficient layout and appropriate use of the land. In addition, these regulations also provide for the accurate surveying of land, preparing and recording of plats, and the equitable handling of all subdivision plats by providing uniform procedures and standards for observance by both the approving authority and subdividers.

- B. AUTHORITY: These regulations are adopted in accordance with the Kentucky Revised Statutes - Chapter 100.111 - 100.991.

SECTION 1.2 TRANSFER OF LOTS: All tracts of land as they exist within Pendleton County on the effective date of these regulations may be subdivided one (1) time, creating one new tract, without Pendleton County Joint Planning Commission approval. Any further divisions of a tract of land as it existed on the effective date of these regulations shall require the approval of the Pendleton County Joint Planning Commission. The second division of a parcel of land as it existed on the effective date of these regulations shall be defined a "lot division", and no lot division may be sold or transferred unless a Plat has been approved by the Pendleton County Joint Planning Commission and recorded with the Pendleton County Clerk. No lot division shall be recorded by the Pendleton County Clerk until a plat has been approved by the Pendleton County Joint Planning Commission and any instrument of land transfer or sale of a lot division without Pendleton County Joint Planning Commission approval shall be void.

SECTION 1.3 GENERAL RESPONSIBILITIES:

- A. **SUBDIVIDER:** The subdivider shall: use a land surveyor and engineer, as defined herein, to prepare plats and plans consistent with the design standards; accomplish improvements consistent with the improvement requirements; and submit said plats and plans in accordance with these regulations.

- B. **PLANNING COMMISSION:** The planning commission, or its duly authorized representative, is charged with the duty of reviewing the design and improvements of proposed subdivisions, and requiring conformance of such subdivisions with the Kentucky Revised Statutes, Chapter 100, and these regulations.

- C. **DELEGATION OF AUTHORITY BY PLANNING COMMISSION TO ITS DULY AUTHORIZED REPRESENTATIVE:** Pursuant to KRS 100, the planning commission has delegated certain authority to its duly authorized representative. However, the planning commission shall have final approval authority over all actions of its duly authorized representative.

ARTICLE II DEFINITIONS

SECTION 2.0 WORDS AND PHRASES: For the purpose of these regulations, certain terms, phrases, words, and their derivatives, are herewith defined as follows:

Words used in the future tense include the present;
Words used in the present tense include the future;
Words used in the singular form include the plural;
Words used in the plural form include the singular;
Words used in the masculine include the feminine;
Words used in the feminine include the masculine;
The word "shall" is mandatory;
The words "may" and "should" are permissive.

ACCESS POINT: An access point is:

- (1) A driveway, a local street, a collector street, or subcollector street, intersecting an arterial street;
- (2) A driveway or a local street intersecting a collector street or sub-collector street; or
- (3) A driveway or a local street intersecting a local street.

AGRICULTURE: The use of a tract of at least five (5) contiguous acres for the production of agriculture or horticulture crops, including but not limited to livestock products, poultry, poultry products, grain, hay, pastures, soybeans, tobacco, timber, orchard fruits, vegetables, flowers or ornamental plants, including provision for dwellings for person and their families who are engaged in the above agricultural use on the tract, but not including residential building development for sale or lease to the public.

ALLEY: Public right-of-way which normally affords a secondary means of access to abutting property.

BLOCK: A parcel of land within a subdivision that is bounded by streets or bounded by streets and the exterior boundary of the subdivision. For this definition, an alley is not considered a street, but part of the block.

BLOCK LENGTH: The distance between intersections of through streets, such distance being measured parallel to the longest street bounding the block and from right-of-way line to right-of-way line of the two intersecting streets.

COMMISSION (OR PLANNING COMMISSION, OR PLANNING AND ZONING COMMISSION): The Pendleton County Joint Planning Commission, State of Kentucky.

COMPREHENSIVE PLAN: The comprehensive plan for Pendleton County, adopted by the Pendleton County Joint Planning Commission. It is a guide for public and private actions and

decisions to assure the development of public and private property in the most appropriate relationships. It shall contain as a minimum, the following elements:

- A. a statement of goals and objectives, principles, policies, and standards;
- B. a land use plan element;
- C. a transportation plan element;
- D. a community facilities plan element;
- E. may include any additional elements, such as, without being limited to: community renewal, housing, flood control, pollution, conservation, natural resources, regional impact and others.

DEVELOPER: Synonymous with the term "subdivider".

EASEMENT: A right, distinct from the ownership of the land, to cross property with facilities such as, but not limited to, sewer lines, water lines, and transmission lines, or the right, distinct from the ownership of the land, to reserve and hold an area for drainage or access purposes.

ENGINEER: A qualified registered professional engineer in good standing with the Kentucky Board of Registration for Professional Engineers and Land Surveyors.

FINAL PLAT: A subdivision plat proposed in accordance with the provisions herein in which said plat is designated to be placed on record with the county clerk after approval by the planning commission's duly authorized representative and signed by the chairman for other officers of the planning commission.

FLOOD: A general and temporary condition of partial or complete inundation of normally dry land areas from: (a) the overflow of inland waters; (b) the unusual and rapid accumulation of runoff of surface waters from any source; and (c) mudslides (i.e., mudflows) which are proximately caused or precipitated by accumulations of water on or under the ground.

FLOOD - 100-YEAR FREQUENCY: The highest level of flooding that, on the average, is likely to occur once every 100 years.

FLOOD PLAIN OR FLOOD PRONE AREA: Any normally dry land area that is susceptible to being inundated by water from any source.

FLOODWAY: The channel of a river or other watercourse and the adjacent land areas that must be reserved in order to discharge the 100-year flood without cumulatively increasing the water surface elevation more than one foot at any point.

FRONTAGE LOT: All the property abutting on one side of the right-of-way of a street, measured along the right-of-way line of the street between the intersecting lot lines. In no case shall the line along an alley be considered as acceptable for frontage.

FRONT YARD DEPTH: The minimum distance required to be maintained within the lot between a line parallel to the front lot line, as defined herein, and the front lot line.

IMPROVEMENT PLANS: The engineering plans showing design layout, types of materials and construction details for the physical structures and facilities to be installed in, or in conjunction with, the subdivision.

INSPECTOR: The planning commission's duly authorized representative, whose responsibility it is to inspect, or cause to be inspected, items required by these regulations.

PENDLETON COUNTY: Refers to both the incorporated and unincorporated areas of Pendleton County, State of Kentucky.

LOT: A parcel of land or any combination of several lots of record, occupied or intended to be occupied by a principal building or a building group.

LOT OF RECORD: Except as otherwise defined by state statutes, a lot, parcel or tract of land designated on a plat, survey or deed, recorded by the office of the county clerk.

LOT AREA: The total area of a horizontal plane bounded by the front, side, and rear lot lines, but not including any area occupied by street, alley, or railroad rights-of-way.

LOT, CORNER: A corner lot is a lot situated at the intersection of two streets or on a curved street on which the interior angle of such intersection or curved street does not exceed one hundred thirty-five (135) degrees.

LOT, DEPTH OF: The distance measured in the mean direction of the side lot lines from the midpoint of the front lot lines to the midpoint of the rear lot lines.

LOT DIVISION (A.K.A. SUBDIVISION) : The division of a parcel of land into three (3) or more lots or parcels for the purpose, whether immediate or future, of sale, lease, or building development, or if a new street is involved, any division of a parcel of land; provided that a division of land for agricultural use and not involving a new street shall not be deemed a subdivision. The term includes resubdivision (as defined herein).

LOT, DOUBLE FRONTAGE: A lot other than a corner lot that has frontage on more than one street.

LOT, INTERIOR: A lot other than a corner lot with only one frontage on a deeded and occupied public right-of-way.

LOT LINE, FRONT: The common boundary line of a lot and a street right-of-way line. In the case of a corner lot or a double frontage lot, the common boundary line and that street right-of-way line toward which the principal or usual entrance to the main building faces.

LOT LINE, REAR: The boundary line of a lot which is most nearly opposite the front lot line of such lot. In the case of a triangular or wedge shaped lot, for measurement purposes only, a line ten (10) feet in length within the lot parallel to and at the maximum distance from the front lot line. In the case of a corner lot, providing that all requirements for yard space are complied with, the owner may choose either side not abutting a street as the rear lot line, even though it is not

opposite the front lot line. Once the choice has been made, it cannot be changed unless all requirements for yard space can be complied with.

LOT LINE, SIDE: Any boundary line of a lot, other than a front lot line or rear lot line.

LOT WIDTH: The width of the lot as measured along the building front setback line.

OFFICIAL MAP: The adopted official map of the applicable legislative body or fiscal court, as provided for in the Kentucky Revised Statutes, Chapter 100.

PRELIMINARY PLAT: A tentative plat of a proposed subdivision prepared in accordance with the provisions herein for presentation to the planning commission for its action.

RESUBDIVISION: Any change in a map of an approved or recorded subdivision plat that affects any street layout on the map or area reserved therein for public use or any lot line, or that affects any map or plan legally recorded prior to the adoption of any regulations controlling subdivisions.

RIGHT-OF-WAY: A general term denoting land, property, or interest therein, usually in a strip and dedicated for or devoted to such uses as a street, alley, or railroad.

STREETS: A vehicular way herein defined:

STREET, PRIVATE: A roadway, constructed to public street standards, which affords access to abutting property for private users of such property.

STREET, PUBLIC: A public roadway, constructed within the boundaries of an officially dedicated public right-of-way, which affords principal means of access to abutting property.

STREET, ARTERIAL: Public thoroughfares which serve the major movements of traffic within and through the community.

STREET, COLLECTOR: Public thoroughfares which serve to collect and distribute traffic primarily from subcollector to arterial streets.

STREET, CUL-DE-SAC OR COURT: A street having an outlet at one end only and having the other end permanently closed with facilities permitting vehicles to turn around.

STREET, DEAD-END: A street having an outlet at one end only and terminated at the other end by undeveloped property. It may or may not have facilities permitting vehicles to turn around.

STREET, EXPRESSWAY: A divided arterial highway for through traffic with full or partial control of access and generally with grade separations at major intersections.

STREET, FREEWAY: A divided multi-lane highway for through traffic with all crossroads separated in grades and with full control of access.

STREET, FRONTAGE ROAD (SERVICE OR ACCESS ROAD): A street adjacent to a freeway, expressway, or arterial street separated therefrom by a dividing strip and providing access to abutting properties.

STREET, LOCAL: Roadways which are designed to be used primarily for direct access to abutting properties.

STREET, SUBCOLLECTOR: A street designed to provide a traffic route from local to collector streets.

SUBDIVIDER: Any individual, firm, association, syndicate, co-partnership, corporation, trust, governmental agency, or any other legal entity commencing proceedings under these regulations, to create a subdivision of land as defined herein for himself or for another.

SUBDIVISION (A.K.A. LOT DIVISION): The division of a parcel of land into three (3) or more lots or parcels for the purpose, whether immediate or future, of sale, lease, or building development, or if a new street is involved, any division of a parcel of land; provided that a division of land for agricultural use and not involving a new street shall not be deemed a subdivision. The term includes resubdivision (as defined herein).

SURVEYOR: A qualified registered land surveyor in good standing with the Kentucky Board of Registration.

TRACT: A parcel of land identified by letter or number, the boundaries of which are shown on the recorded subdivision plat.

WATERCOURSE: A permanent channel designed to carry concentrated stormwater flows without erosion; applicable to open channels, roadside ditches and natural channels that are modified to accommodate increased flows generated by land development.

**ARTICLE III
SUBDIVISION PROCEDURE**

Any person desiring to subdivide any lot, tract, or parcel of land, or to change or rearrange any lot, tract, or parcel of land within Pendleton County, shall comply with the procedures established in this article and other applicable articles and sections of these regulations and in the specified sequence.

SECTION 3.0 PRELIMINARY INFORMATION: The subdivider is encouraged to notify the planning commission, or its duly authorized representative, of their intention to subdivide a property prior to submission of the Preliminary Plat. Such notification should include mention or illustration of any aspect or feature which will affect the design or layout of the subdivision. For clarity, the subdivider may utilize a map to illustrate various features or aspects of the property.

SECTION 3.1 SUBMISSION OF PRELIMINARY PLAT: The subdivider shall file fifteen (15) copies of the Preliminary Plat with the planning commission's duly authorized representative, prepared in accordance with the requirements of Article 3.0, at least twenty-eight (28) consecutive days prior to the next regular meeting of the planning commission. Such submission shall be considered the date of official filing. At this time, the following material shall also be filed with the commission's duly authorized representative, where applicable.

A. APPLICATION FOR PRELIMINARY PLAT APPROVAL:

An application (provided by the commission) shall be submitted. At the time of submission, the commission's duly authorized representative shall note on the application the date of submission and signature of the subdivider.

B. INDIVIDUAL ON-SITE DISPOSAL SYSTEM PERMIT:

Where individual on-site disposal systems have been approved, as per Section 7.1 of these regulations, the following note shall be included on the plat: "Plat approval for building development on lot(s) is contingent upon issuance of a final sewage construction permit and inspections by the Pendleton County Health Department based upon a site evaluation and approved system.

C. PRELIMINARY PLAT FEES:

Preliminary Plat and Certificate of Land Use Restriction fees shall be submitted as established by the planning commission's By-Laws.

SECTION 3.2 PROCESSING OF THE PRELIMINARY PLAT: Within three (3) working days after the date of filing of the Preliminary Plat, the planning commission's duly authorized representative shall notify the local and state governmental agencies, and other organizations of the public meeting, and transmit copies of the proposed Preliminary Plat (number of agencies notified including copies forwarded shall be determined from a checklist on the application provided by the planning commission's duly authorized representative).

The local and state governmental agencies and other affected organizations shall forward their recommendations and/or comments, if any, to the planning commission or its duly authorized

representative prior to or at the meeting of the planning commission at which the issue will be heard.

The Preliminary Plat, the application, and all other required information, shall be checked by the planning commission's duly authorized representative for compliance with: (1) the requirements of the Preliminary Plat as per Article IV; and (2) any other pertinent sections of applicable regulations.

SECTION 3.3 PLANNING COMMISSION ACTION: The commission's duly authorized representative shall review the Preliminary Plat, including determination of its conformance to the requirements of these regulations, and shall consider the recommendations and/or comments of all applicable local and state governmental agencies and other applicable organizations, and shall forward such recommendations and/or comments to the planning commission along with its recommendations. The planning commission shall then review the recommendation of its duly authorized representative and/or comments of all applicable local and state governmental and other affected organizations, and take one of the following actions: (1) approve the plat; (2) approve the plat, subject to conditions; or (3) disapprove the plat; within two consecutive meetings from date of official filing, unless such time is extended by agreement between the planning commission and the subdivider.

In the event of approval, conditional approval, or disapproval of the Preliminary Plat, a statement, in writing, by the planning commission or its duly authorized representative, setting forth the conditions of approval, or reasons for disapproval, shall be submitted to the subdivider.

Approval or conditional approval of a Preliminary Plat shall be valid and not subject to additional requirements for a period of twenty-four (24) consecutive calendar months, except that if a portion of an approved Preliminary Plat is approved or conditionally approved as Improvement Drawings and Specifications or a Final Plat, said approval or conditional approval of the remainder of the Preliminary Plat shall be valid for twenty-four (24) consecutive calendar months after the date of approval or conditional approval of said Improvement Drawings and Specifications or Final Plat. The planning commission may, upon receipt of a request by the subdivider, grant an extension to this twenty-four (24) month period if prevailing conditions have not changed appreciably.

SECTION 3.4 SUBMISSION AND PROCESSING OF PRELIMINARY GRADING PLANS AND/OR EROSION AND SEDIMENTATION CONTROL PLANS: Following approval or conditional approval of the Preliminary Plat, the subdivider may elect to proceed with preliminary grading of the area to be subdivided, provided that plans for erosion and sedimentation (as per Section 7.12) are submitted to the planning commission's duly authorized representative who shall check the erosion and sedimentation plans for preliminary grading to insure their conformance with the approved or conditionally approved Preliminary Plat and other pertinent sections of these regulations. Following this review, the planning commission's duly authorized representative shall take one of the following actions: (1) approve the erosion and sedimentation plans for preliminary grading; (2) cause to revise or approve the erosion and sedimentation plans for preliminary grading, subject to conditions; or (3) disapprove the erosion and sedimentation plans for preliminary grading. In the event of conditional approval or disapproval, a statement, in writing, by the planning commission's duly authorized representative, setting forth the conditions of approval or the reasons for disapproval, shall be

submitted to the subdivider. Three (3) copies of Grading Plans and/or Erosion and Sedimentation Control Plans, for final approval with conditions as required, shall be submitted to the planning commission's duly authorized representative prior to start of construction.

SECTION 3.5 SUBMISSION OF IMPROVEMENT DRAWINGS AND SPECIFICATIONS:

Following approval or conditional approval of the Preliminary Plat by the planning commission, the subdivider may elect to submit the Improvement Drawings and Specifications to the planning commission's duly authorized representative for review and approval, prior to the submission of the Final Plat. It shall also be the responsibility of the subdivider to submit copies of the Improvement Drawings and Specifications to the applicable local and state governmental agencies and other organizations affected by the subdivision. Said Improvement Drawings and Specifications shall include at least the area intended for processing as a Final Plat. At this time, the subdivider shall submit to the planning commission's duly authorized representative the following:

1. One (1) copy of the Sanitary Sewerage and Storm System Plans and Profiles (as per Sections 7.1 and 7.0).
2. One (1) copy of the Water System Plans (as per Section 7.2).
3. One (1) copy of the Street Plans and Profiles, including typical cross sections (as per Section 7.3).
4. One (1) copy of the Drainage Report, including computations (as per Section 7.0).
5. One (1) copy of grading plans including control of erosion and sedimentation (as per Section 7.12) if not submitted previously for processing as per Section 3.4.
6. Plan review and construction review fees as established by the planning commission's By-Laws.

SECTION 3.6 PROCESSING OF IMPROVEMENT DRAWINGS AND SPECIFICATIONS:

The planning commission's duly authorized representative shall check the Improvement Drawings and Specifications to insure they are in conformance with the approved or conditionally approved Preliminary Plat and that they meet all applicable requirements established in these regulations. The planning commission's duly authorized representative shall cause to have the subdivider's engineer incorporate requirements of all applicable local and state governmental agencies and other organizations as they pertain to the proposed Improvement Drawings and Specifications. Following these reviews, the planning commission's duly authorized representative shall take one of the following actions: (1) approve the Improvement Drawings and Specifications; (2) cause to revise or approve the Improvement Drawings and Specifications, subject to conditions; or (3) disapprove the Improvement Drawings and Specifications. In the event of revisions, conditional approval, approval or disapproval, a statement, in writing, by the planning commission's duly authorized representative, setting forth the reasons for such action shall be submitted to the subdivider. Three (3) copies of Improvement Drawings and Specifications shall be submitted to the planning commission's duly authorized representative, for final approval, with all conditions as required prior to start of construction.

SECTION 3.7 SUBMISSION OF THE FINAL PLAT:

- A. **GENERAL:** Except as provided herein, the Final Plat shall only be submitted after the Preliminary Plat has been approved, or conditionally approved. The Final Plat shall

conform to the approved or conditionally approved Preliminary Plat and shall include all changes, additions, deletions, or approvals as may be required per conditional approval by the commission, or its duly authorized representative and shall be prepared in accordance with Article V and other applicable sections of these regulations. Resubdivisions of previously approved or recorded Final Plats which do not involve new building development may be submitted without a Preliminary Plat and processed in accord with Section 3.8 of these regulations.

- B. PREPARATION: The subdivider may cause, within twenty-four (24) consecutive calendar months after the approval or conditional approval of the Preliminary Plat or Improvement Drawings and Specifications, the subdivision or any part thereof, to be surveyed and a Final Plat thereof to be prepared. Except as required within Section 7.3 J regarding street interconnection/extension, the Final Plat shall contain only that portion of the approved or conditionally approved Preliminary Plat and Improvement Drawings and Specifications, where applicable, which the subdivider wishes to have approved, recorded and developed at that time. Final Plats which are a portion of the approved or conditionally approved Preliminary Plat shall be named and listed as "SECTION NO. (XX) of (*Name of Subdivision*)". Final Plats which are resubdivisions of approved and recorded Final Plats shall be labeled as "RESUBDIVISION OF (*Appropriate Listing Title* - lots, Section No., Subdivision Name)". The subdivider shall ensure that the Final Plat is prepared under the supervision of a registered land surveyor.
- C. FILING: The subdivider shall submit, to the planning commission's duly authorized representative, two (2) copies of the Final Plat drawing prepared in accordance with Article V of these regulations for review. At this time, the following material shall also be filed with the commission's duly authorized representative, unless otherwise noted:
1. Application for Final Plat approval: An application (provided by the commission) shall be submitted. At the time of submission, the commission's duly authorized representative shall note, on the application, the date of submission and signature of the subdivider.
 2. Traverse sheets or other closure documentation: As referenced on the plat. In no case shall the unadjusted linear error of closure of the actual field traverse be less than a minimum ratio of 1:5000 for a class B survey and 1:10000 for a class A survey. The closure accuracy required shall include a closed traverse of the subdivision boundaries (as per Article V).
 3. Improvement Drawings and Specifications: Improvement Drawings and Specifications will be required, if not submitted previously for processing, in accord with Section 3.5.
 4. Record Copies of Improvement Drawings: Where the Improvement Drawings and Specifications were previously submitted and approved prior to the submission of the Final Plat, and where construction of the public improvements reflect significant changes from the originally approved improvement drawings, the subdivider shall submit one (1) reproducible mylar of Record Copies of Improvement Drawings including

plans and profiles for streets, sanitary sewerage and storm system and water system.

5. Special Testing Reports: All required testing reports including soils (i.e., embankments, subgrade, utility trenches), sanitary sewers (i.e., low pressure air acceptance) storm sewers (i.e., larger than 30 - diameter) and concrete street paving (i.e., strength, slump, air content and cylinder tests).
6. Fees: Plan review, plat review, construction review and recording fees shall be submitted as established by the planning commission's By-Laws.
7. Guarantee: A guarantee (if applicable) per Section 7.16 of these regulations.

SECTION 3.8 PROCESSING OF THE FINAL PLAT AND WHERE APPLICABLE, THE IMPROVEMENT DRAWINGS AND SPECIFICATIONS: The planning commission's duly authorized representative shall check the Final Plat as to conformity with the approved, or conditionally approved, Preliminary Plat and all other pertinent aspects as required in Article V and other applicable sections of these regulations. Following review, the planning commission's duly authorized representative shall recommend one of the following actions: (1) approve the Final Plat; (2) cause to revise the Final Plat, subject to conditions; or (3) disapprove the Final Plat. Should the planning commission's duly authorized representative decide to cause revisions to be made or recommend disapproval of the Final Plat, written notice of such action, including the revisions or reasons for disapproval shall be mailed to the subdivider by the planning commission's duly authorized representative. Where applicable, the planning commission's duly authorized representative shall also check the Improvement Drawings and Specifications, drainage plans, plans for erosion and sedimentation control and the Record Copies of Improvement Drawings (required as per Section 3.7 C.4) for their conformity to the Final Plat.

SECTION 3.9 PLANNING COMMISSION ACTION: Following the review of the Final Plat the planning commission's duly authorized representative shall take one of the following final actions:

- A. FINAL APPROVAL -- final approval of a plat shall be recommended in one of two ways:
 1. After completion of improvements: After the subdivider has obtained approval or conditional approval and has completed all required improvements and the required improvements have been inspected and found to be in compliance with these regulations, the planning commission's duly authorized representative shall recommend final approval. The original drawing of the Final Plat shall then be signed and dated by the chairman or other duly authorized officer of the planning commission.
 2. Before completion of improvements: The planning commission's duly authorized representative may recommend final approval before all required improvements are completed, provided that a guarantee is provided for the purpose of assuring completion of such improvements. The amount of the

guarantee shall be based on an estimate made by the subdivider's engineer. Type of guarantee shall be a good and sufficient surety bonds acceptable to the planning commission's legal counsel. All guarantees shall be approved by the planning commission's duly authorized representative. Upon determination that all requirements of these regulations have been met, the planning commission's duly authorized representative may recommend final approval. The original drawing of the Final Plat may then be signed and dated by the chairman or otherwise duly authorized officer of the planning commission. The guarantee shall not be returned to the subdivider until all improvements have been completed, inspected, and found to be in compliance with these regulations.

SECTION 3.10 EFFECT OF APPROVAL: After the Final Plat has been reviewed by the planning commission's duly authorized representative, and all changes, additions, deletions, etc. made, two (2) sets of original reproducible mylars and six (6) paper copies for Final Plats and condominium property regime plats shall be submitted for final approval. Said mylars or originals shall include all certificates, acknowledgements, endorsements, and notary seals and all signatures completed in original ink, except for signatures of the chairman or other duly authorized officer of the Commission and county clerk (e.g., copies of plat signatures are not acceptable by the county clerk for recording). Following this review, the Final Plat may be recommended for approval by the planning commission's duly authorized representative, and signed by the chairman or other duly authorized officer of the planning commission. Disposition and recording shall be as specified in Sections 3.11 of these regulations.

SECTION 3.11 DISPOSITION AND RECORDING OF APPROVED FINAL PLAT: After approval of the Final Plat signed by the chairman or other duly authorized officer of the planning commission, the planning commission's duly authorized representative shall forward one (1) original mylar to the county clerk's office for recording. Copies of Final Plats and condominium property regime plats shall be forwarded to the legislative body, post office, and related utilities (i.e., Union Light Heat & Power Co., or Owen Electric Cooperative, water district or agency and Cincinnati Bell, Inc.) by the planning commission's duly authorized representative following final action at regular monthly meetings.

SECTION 3.12 ACCEPTANCE OF IMPROVEMENTS FOR MAINTENANCE AND/OR LAND OFFERED FOR DEDICATION: After all improvements have been installed in accordance with the approved Improvement Drawings and Specifications and the record copies of drawings have been submitted, and the inspector has indicated that inspections were made and approved (as per Section 7.13), the applicable legislative body or other applicable public body should accept the improvements for maintenance (or in the case of lands to be dedicated, may accept such lands in fee simple, by easement, or other such instrument approved by the applicable governmental body), pursuant to applicable state statutes and other applicable regulations. Acceptance of any street or other public ground is regulated by KRS 100.277(4).

SECTION 3.13 SUBMISSION AND PROCESSING OF CONDOMINIUM PROPERTY REGIME PLATS:

- A. **GENERAL:** In accord with the Horizontal Property Law (KRS 381) whenever a developer, the sole owner, or the co-owners of a building or buildings constructed or to

be constructed, expressly declare, through the recording of a master deed or lease, a condominium property regime may be established. Once the property is submitted to the condominium property regime, a unit in the building(s) may be individually conveyed and may be the subject of ownership possession or sale and other acts as if it were sole and entirely independent of the other units in the building(s) of which they form a part and the corresponding individual titles and interest shall be recordable. It is the purpose of the condominium property regime plat to provide a process whereby two or more apartments, town-houses, rooms, office spaces, or other units in existing or proposed buildings or structures may be subdivided and offered or proposed to be offered for sale in accordance with requirements as established by these regulations. In order to be processed as a condominium property regime plat, the following requirements must be met in addition to other requirements of these regulations and applicable state statutes:

1. For proposed projects including buildings involving private or public improvements, prior to the review of a condominium property regime plat, a Preliminary Plat and Improvement Drawings and Specifications are required to be submitted for processing in accord with these regulations.
2. For existing building conversions not involving public improvements, submission and processing shall be in accord with Section 3.13 B and C, respectively.

B. SUBMISSION OF CONDOMINIUM PROPERTY REGIME PLATS: In addition to the above requirements, the developer shall submit to the planning commission's duly authorized representative, two (2) copies of the Condominium Property Regime Plat drawing prepared in accordance with Article V of these regulations bearing the certification of a registered land surveyor for review. In addition to other requirements of these regulations, the Condominium Property Regime Plat shall show the location of the building or buildings proposed for the condominium project. Simultaneously, with the submission of the Condominium Property Regime Plat, there shall be attached two (2) copies of a set of floor plans of the building or buildings in accord with state statutes bearing the certification of a registered architect or professional engineer. In addition to other requirements, elevations based upon the North American Datum of 1929 or latest revision, shall be noted on the plats or plans as a reference on each floor or unit for sale.

At this time, the following information shall be filed with the planning commission's duly authorized representative:

1. Application for Condominium Property Regime Plat Approval: An application form provided by the commission, shall be submitted at the time of filing for Condominium Property Regime Plat approval.
2. Traverse Sheets or other closure certification referenced on the plat. The closure accuracy required shall include a closed traverse of the condominium project boundaries (as per Section 5.0).

3. Condominium Property Regime Plat Fees: Plat review, construction review and recording fees shall be submitted as established by the planning commission's By-Laws, where applicable.

C. **PROCESSING OF CONDOMINIUM PROPERTY REGIME PLATS:** The planning commission's duly authorized representative shall review the condominium property regime plats for conformance to the applicable requirements of Article V, the requirements of this section, other pertinent sections of these regulations and minimum standards of practice for land surveying in Kentucky. Following the review, the planning commission's duly authorized representative shall recommend one of the following actions: (1) approve the condominium property regime plats; (2) cause to revise the condominium property regime plats subject to conditions; or (3) disapprove the condominium property regime plats. Should the planning commission's duly authorized representative recommend revision or disapproval of the condominium property regime plats, written notice of such action, including the reasons for revision, disapproval, shall be mailed to the subdivider by the planning commission's duly authorized representative. The action shall be entered in the official records of the planning commission's duly authorized representative and the planning commission. After final review of the condominium property regime plats by the planning commission's duly authorized representative, the subdivider shall submit two (2) reproducible mylars and ten (10) copies of plats to the planning commission's duly authorized representative for disposition per the requirements of Section 3.11. If approved and signed by the chairman or other duly authorized officer of the planning commission, the original condominium property regime plats may be recorded in the office of the county clerk.

SECTION 3.14 SUBMISSION AND PROCESSING OF IDENTIFICATION PLATS:

A. **GENERAL:** It is the purpose of the identification plat to provide a process whereby parcels may be subdivided (i.e. subdivisions) without having to be processed through preliminary and final plat procedures, as established in these regulations. In order for a subdivision to be processed as an identification plat, the following requirements must be met in addition to other requirements of these regulations:

1. The parcel to be subdivided shall not involve construction of any public improvements including water lines, storm and sanitary sewers, and streets, etc. for which preliminary and final plat processes are required.
2. In areas not served by a public sanitary sewer system, land surveyed for conveyance which is less than one (1) acre shall be labeled "Not for conveyance or building development by itself, but for attachment to adjacent land in the same ownership".
3. Tracts or parcels surveyed in areas approved or conditionally approved as a Preliminary Plat that are not for building development by themselves but are for attachment to adjacent land in the same ownership, shall contain the following statement: "Not for conveyance or building development by itself, but for attachment to adjacent land in the same ownership. Any development within tract or further subdivision must comply with

previously approved Preliminary Plat with conditions on file at planning commission offices unless amended via submission of revised plans".

4. Except as noted in item 3 (above) the identification plat process shall not be permitted in areas already approved or conditionally approved as a preliminary plat.

B. **SUBMISSION OF THE IDENTIFICATION PLAT:** The subdivider shall submit to the planning commission's duly authorized representative, two (2) copies of the identification plat at a size measuring 8-1/2" x 11" or 8-1/2" x 14" (intended for attachment to a deed), prepared in accordance with the applicable requirements of these regulations and minimum standards of practice for Land Surveying in Kentucky, latest revision, as defined in KRS 322. In addition, the identification plat shall also contain the following information:

1. A statement by a registered land surveyor preparing the plat that the parcel contains no proposed public improvements.
2. A statement by a registered land surveyor preparing the plat that plat approval for residential building development is contingent upon issuance of a sewage construction permit from the Pendleton County Health Department, where applicable.
3. In areas not served by a public sanitary sewer system, land surveyed for conveyance which is less than one (1) acre shall be labeled "Not for conveyance or building development by itself, but for attachment to adjacent land in the same ownership".
4. Sufficient information shall be included to locate the parcel being subdivided in relation to the previous subdivided parcels, as well as their location within the tract of land as it existed on the effective date of these regulations.
5. Existing rights-of-way widths shall be determined from existing deeds or lots of record and other statutes or agencies establishing such widths. Subdivisions platted along existing streets shall dedicate additional right-of-way, if necessary, to meet the minimum street width requirements set forth in the applicable section(s) of these regulations. Such dedication shall be in accordance with the following: a. At least the minimum right-of-way width shall be dedicated where the subdivision is on both sides of an existing street. b. When the subdivision is located on only one side of an existing street, one-half (1/2) of the required right-of-way width, measured from the centerline of the right-of-way, shall be dedicated. However, the owner or owners of such property shall not be required to dedicate more than one-half (1/2) of the required rights-of-way width.

6. A vicinity map drawn at a scale of one (1) inch to two thousand (2,000) feet or greater (e.g., one (1) inch to one thousand (1,000) feet) on the plat showing, within one-half (1/2) mile of the proposed subdivision, existing roads and other significant features (e.g., streams, lakes, etc.).
- C. At this time, the following information shall also be filed with the planning commission's duly authorized representative:
1. Application for Identification Plat Approval: An application (provided by the commission) shall be submitted at the time of submission. The commission's duly authorized representative shall indicate on the application the date of submission and signature of the commission's duly authorized representative.
 2. Traverse Sheets or other closure certification referenced on the plat: The closure accuracy required shall include a closed traverse of the subdivision boundaries as per Section 5.0.
 3. Description: One copy of the description written by a land surveyor for the purpose of defining complete land boundaries accurately describing the actual boundary survey.
 4. Identification Plat Fees: Plat review, construction review and recording fees shall be submitted as established by the planning commission's By-Laws.
- D. PROCESSING OF IDENTIFICATION PLAT: The planning commission's duly authorized representative shall review the identification plat as per the applicable requirements of these regulations and minimum standards of practice for land surveying in Kentucky. Following the review, the planning commission's duly authorized representative shall recommend one of the following actions: (1) approve the identification plat; (2) cause to revise the identification plat subject to conditions; or (3) disapprove the identification plat. Should the planning commission's duly authorized representative recommend revision or disapproval of the identification plat, written notice of such action, including the plat revisions or reasons for disapproval shall be mailed to the subdivider by the planning commission's duly authorized representative. After final review of the identification plat by the planning commission's duly authorized representative, two (2) originals and one (1) copy of the plat shall be submitted to the planning commission's duly authorized representative for final approval and disposition, per the requirements of Section 3.11. The action shall be entered in the official records of the planning commission's duly authorized representative and the planning commission. If approved and signed by the chairman or other duly authorized officer of the planning commission, the planning commission's duly authorized representative shall deliver the plats to the Pendleton County clerk where they may be recorded with the deeds or other documents.

**ARTICLE IV
PRELIMINARY PLAT REQUIREMENTS**

SECTION 4.0 SPECIFICATIONS FOR AND CONTENT OF THE PRELIMINARY PLAT:
The following information shall be clearly shown on or accompany the Preliminary Plat:

The subdivider shall file with the planning commission's duly authorized representative fifteen (15) copies of the Preliminary Plat for review. Such plat shall be drawn at a scale of one (1) inch to two hundred (200) feet or greater (e.g., one (1) inch to one hundred (100) feet).

A. INFORMATION TO BE CONTAINED ON PRELIMINARY PLAT:

1. Proposed name of subdivision, which shall not duplicate or too closely approximate, phonetically, or in spelling, the name of any other subdivision in the county;
2. Name, address, and phone number of record owner(s);
3. Name, address, and phone number of subdivider(s);
4. Name, address, and phone number of person, firm, or organization preparing the Preliminary Plat, with the seal and signature of the registered professional engineer or land surveyor responsible for its preparation, where applicable;
5. North point, written and graphic scale, and date;
6. Vicinity sketch map: a vicinity sketch map drawn at a scale of one (1) inch to two thousand (2,000) feet or greater (e.g., one (1) inch to one thousand (1,000) feet), including the following information, if applicable, within at least one-half (1/2) mile of the proposed subdivision:
 - a. Proposed subdivision name and location;
 - b. Existing and proposed streets;
 - c. Other significant features (e.g., streams, lakes, etc.);
 - d. Original parent tract deed book and page, group and remaining acreage.
7. The perimeter boundary lines of the tract to be subdivided and submitted as a Preliminary Plat shall be drawn to scale showing all bearings and distances;
8. The existing use or uses of the property and, to scale, the outline of any existing buildings or improvements to be retained and their location in relation to existing or proposed street and lot line locations (addresses if available);

9. The right-of-way lines and names of all existing or platted streets, other public ways and easements adjacent to or in connection with the subdivision including right-of-way widths and other important features at least within one hundred (100) feet of the boundary lines, such as railroad lines, watercourses, etc.;
10. Names of adjacent subdivisions and the property lines, at least within one hundred (100) feet of the subdivision boundary, and owners of record of all adjacent parcels that are unsubdivided (for adjacent platted land, refer to subdivision plat by name, plat book, and page);
11. Location and dimensions of all existing easements and rights-of-way within the subdivision;
12. Existing utilities on and adjacent to the subdivision: location and size of water mains, sanitary, storm and/or combined sewers;
13. Existing contours at ten (10) foot intervals within the subdivision;
14. Subsurface conditions on the subdivision; any known conditions that are not typical, or which may cause problems, such as: soils and geological formations, old mine shafts, wells, known mineral deposits, etc.
15. Proposals:
 - a. streets and alleys: layout, names, right-of-way and pavement widths, approximate corner radii at the right-of-way line and the approximate proposed grades of all streets;
 - b. other rights-of-way or easements: location, width, and purpose;
 - c. Lots: lots and blocks numbered;
 - d. Water and Sewer Systems: plan view layout of water lines, storm and sanitary sewer lines, including sizes, to serve the subdivision;
16. Statement of the lot area of the smallest lot in the subdivision (reference shall be made to the lot and block number);
17. Parcels of land intended to be dedicated or temporarily reserved for public use, or to be reserved by deed restriction or protective covenant for use by all property owners in the subdivision or parcels of land or lots to be used for any purpose other than private, shall be so designated;
18. Proposed uses for all land in the subdivision;

19. Approximate boundaries of areas subject to flood of 100-year frequency (including 100-year floodway) and the location, width, and direction of flow of all watercourses, lakes, marshy areas, and swamps;
20. Total site data: including acreage, number of lots, and, if applicable, approximate number of square feet or acres in parks and other public uses.

B. ADDITIONAL INFORMATION TO BE SUBMITTED AT TIME OF FILING OF PRELIMINARY PLAT:

1. One (1) copy of an application for Preliminary Plat approval (provided by the commission);
2. Where individual on-site disposal systems have been approved, as per Section 7.1(d) of these regulations, the following note shall be included on the plat: "Plat approval for building development on lot(s) is contingent upon issuance of a final sewage construction permit and inspections by the Pendleton County Health Department based upon a site evaluation and approved system;
3. One (1) copy of applicable board of adjustments action identifying any dimensional variances granted, if applicable;
4. Plat review fees as established by the planning commission's By-laws.

ARTICLE V
FINAL PLAT REQUIREMENTS INCLUDING
IMPROVEMENT DRAWINGS AND SPECIFICATIONS

SECTION 5.0 SPECIFICATIONS FOR AND CONTENT OF THE FINAL PLAT: The subdivider shall file with the planning commission's duly authorized representative, two (2) copies of the Final Plat for review. Following review, the subdivider shall submit ten (10) copies of the Final Plat for disposition and two (2) sets of original reproducible mylars to the planning commission's duly authorized representative for record purposes. The Final Plat shall be drawn at a scale of one (1) inch to fifty (50) feet or greater (e.g., one (1) inch to thirty (30) feet). However, if the Final Plat will contain lots of one hundred (100) feet or greater, fronting along a street, then a scale of one (1) inch to one hundred (100) feet or greater may be used.

Where necessary, the Final Plat may be on several sheets accompanied by an index showing the entire subdivision. The particular number of the sheet, the total number of sheets, and the relation of each adjoining sheet shall be clearly shown by a small key map on each sheet. Each sheet of said plat shall show the north point, written and graphic scale and the date. The Final Plat shall contain a vicinity map showing the location of the subdivision with relation to at least one (1) east/west and one (1) north/ south major arterial. The Final Plat shall further show the following, including all mathematical information and data necessary to locate and retrace any of the required data thereon:

A. INFORMATION TO BE CONTAINED ON FINAL PLAT:

1. The boundary lines of the Final Plat shall be drawn in heavy solid lines with accurate lengths and bearings. These boundaries shall be determined by an accurate field survey, which shall be balanced and closed. All lines shown on the Plat which do not constitute a part of the subdivision shall be dashed. Any area enclosed by the subdivision, but not a part thereof, shall be labeled "Not A Part Of This Subdivision".
2. The exact location and the widths of all existing or recorded streets, intersecting or paralleling the boundaries of the subdivision at least within one hundred (100) feet.
3. The exact location and width of all abutting lot lines. Names of recorded owners of adjoining unplatted land and reference to subdivision plats of adjoining platted land by name, plat book, and page.
4. The boundary line of the proposed Final Plat shall be tied by bearings and distances to a selected point or points (described on the plat) on the nearest established centerline or right-of-way line of any street or highway or a previously established monument(s) in which case the location of said monument shall be identified and accurately described on the plat. In addition, the Final Plat shall be tied by bearings and distances to a point in the original parent tract.

5. Municipal and county boundaries lines, if applicable.
6. The exact layout of the subdivision showing:
 - a. Street and alley centerlines and right-of-way lines shall be graphically shown; street names and bearings and distances along centerlines;
 - b. Sufficient linear, angular, and curve data (at least Delta, Tangent, Radius, and Length of Curve) to readily determine the bearing and length of the boundary lines of every block, lot and tract which is a part of the subdivision.
 - c. All easements or other rights-of-way (the limitation of the easement rights shall be stated or referenced on the plat).
 - d. All lot lines with dimensions and bearings.
7. Identification of any waivers of the subdivision regulations granted by the planning commission, such as: sidewalks on one side of the street; width of street pavement; any need for additional off-street parking spaces; etc.
8. All blocks and lots numbered or lettered in a consecutive manner with no omissions or duplications. Ditto marks shall not be used for lot dimensions. Tracts offered for dedication, other than for streets or easements shall be designated by letter or number (further, the accurate outline of all such tracts shall be shown with the proposed use indicated thereon).
9. All permanent monuments set or to be set shall be shown on the Final Plat:
 - a. The location of all monuments placed in making the survey and if any points were reset, that fact shall be stated and attached to Final Plat for recording.
 - b. Monuments shall be set at intersections of street centerlines and curve points or offsets therefrom. The exact location of all such documents shall be shown on the Final Plat before approval is requested.
10. The accurate outline of all property (if applicable) which is to be reserved by deed restriction or protective covenant for the common use of the property owners in the subdivision.
11. Flood Hazard Information: Elevation and flood profiles shall be shown on the Final Plat if required (as determined as per Section 6.4 of these regulations).

12. All easements shall be shown by a fine dashed line and clearly labeled and identified on the plat. If an easement shown on the plat is already of record, its recorded reference must be given.
13. Name of the subdivision and name or number of the larger subdivision or tract of which the tract now being subdivided is a part.
14. North point (approximating true north), written and graphic scale, and date.
15. Total site data: including acreage, and, if applicable, number of square feet or acres in parks and other public uses.
16. Certification, acknowledgements and descriptions: The following certificates, acknowledgements, and descriptions shall appear on the title sheet of the Final Plat.
 - a. Dedication certificates: a notarized certificate shall be signed and acknowledged offering for dedication all parcels of land shown on the Final Plat which are intended for public dedication.
 - b. Surveyor's certificate: a certificate shall be signed in original ink and dated by a Registered Land Surveyor, in Kentucky, stating that he is responsible for the survey and that the Final Plat accurately depicts the subdivision and the survey. The original signature of such surveyor must be accompanied by his seal and registration number and date.
 - c. Reference of property from which the plat is taken: each reference in such description to any tract, development, or subdivision, shall show a complete reference to records of the county.
 - d. Other affidavits, etc.: the title sheet shall contain such other affidavits, certificates, acknowledgements, endorsements, and notarial seals as are required by law and by these regulations. If such documents are recorded elsewhere, then reference to such documents should be included on the Final Plat.
 - e. Certificate of approval by the chairman or other duly authorized officer of the planning commission.
 - f. Certificate of acceptance for recording by the county clerk.

B. ADDITIONAL INFORMATION TO BE SUBMITTED AT TIME OF FILING FINAL PLAT:

1. One (1) copy of an application for Final Plat approval provided by the commission.
2. Traverse calculations or other closure certification referenced on the plat, resulting from an accurate and complete boundary survey of the perimeter of the Final Plat. Traverse calculations when computed from field measurements, on the ground, shall close with an error of closure not to exceed 1:5000 for a class B survey and 1:10000 for a class A survey.
3. Improvement Drawings and Specifications: Improvement Drawings and Specifications will be required, if not submitted previously for processing, in accord with Section 3.5.
4. Record Copies of Improvement Drawings where applicable.
5. One (1) copy of all deed restrictions or protective covenants (may be either placed directly on the Final Plat, or if separately recorded, reference is made on the Final Plat).
6. Final Plat and construction review fees: Final Plat and construction review fees shall be submitted as established by the planning commission's By-laws.
7. Guarantee: a guarantee (if applicable) per Section 7.12.
8. Recording fees: the subdivider shall pay the recording fee, per requirements of the county clerk.

ARTICLE VI
DESIGN STANDARDS FOR THE LAYOUT OF SUBDIVISIONS

SECTION 6.0 STREETS

- A. Conformity to comprehensive plan and/or official map: whenever a tract of land to be subdivided or resubdivided includes any part of, or is adjacent to, a proposed arterial or collector street as designated on the comprehensive plan and/or the official map, the subdivider shall meet with the planning commission's duly authorized representative to determine its compliance (e.g., right-of-way width for future widening and pavement widths) and resulting design requirements, of such locations, otherwise such street right-of-way shall be platted by the subdivider in the exact location so designated and at the width indicated in these regulations.
- B. Street Extension:
1. Existing Streets: the arrangement of streets in new subdivisions shall make provision for the proper continuation of existing streets in adjoining areas, unless determined otherwise by the planning commission, or its duly authorized representative.
 2. Adjacent Property: where adjoining areas are not subdivided and are appropriate for future development, arrangement of streets in new subdivisions shall make provision for the proper projection of streets to those adjoining areas in a manner which shall provide for the practical development of the adjacent property.
 3. Half Streets: dedication of one-half (1/2) of the rights-of-way (half streets) for streets proposed along the boundaries of land to be subdivided, shall be prohibited.
- C. Street Classification and Function:
1. Arterial Streets: Arterial streets should be planned so as to provide for the smooth flow of traffic between points of heavy traffic generation and from one section of the community or communities to another. Such arterial streets should not traverse the entire community or communities. Arterial streets should not bisect neighborhoods but should act as boundaries between such neighborhoods. Direct access onto the roadway from abutting properties shall be discouraged.
 2. Collector Streets: Collector streets should be designed to provide a traffic route from subcollector streets to arterial streets. These streets should be designed to carry traffic which has an origin or destination within the

neighborhood and between arterial streets. Said streets shall be designed in such a manner to discourage "short cuts" through the neighborhood. Direct access to abutting property should be discouraged whenever possible.

3. Subcollector Streets: Subcollector streets shall be designed to provide a traffic route from local streets to collector streets. Said streets will serve equally both traffic movement and abutting properties.
4. Local Streets, including Cul-de-sacs and courts: Local streets shall provide direct and full access to each lot and direct traffic movement to another local street or to a subcollector street. Said streets shall be laid out so that their use by through traffic will be discouraged. Local street intersections with arterial streets shall be discouraged, wherever practical.
5. Frontage Roads: Frontage roads may be required along an existing or proposed arterial street to provide access to lots along such streets.
6. Alleys: Where alleys are to be provided (e.g., in the case of certain commercial development), they shall be designed to provide only secondary access.

D. Street Rights-of-Way:

1. Widths and grades of new streets: Street right-of-way widths and grades shall conform to the following minimum requirements:

TABLE 1 - STREET RIGHTS-OF-WAY WIDTH AND GRADE REQUIREMENTS

TYPE OF STREET	MINIMUM RIGHT-OF-WAY WIDTH (IN FEET) ***	GRADES BY PERCENT (%)	
		MAX.	MIN.
ARTERIAL	*	*	*
COLLECTOR	60	10	0.5
SUBCOLLECTOR	50	12	0.8
LOCAL (INCLUDING CUL-DE-SACS)****			
Residential	50	12	0.8
Commercial and Industrial Areas	60	10	0.8
COURTS	40	12	0.8
FRONTAGE ROAD	**	**	**
ALLEYS	20	10	0.5

- * Arterial streets shall be based on current design standards and other pertinent requirements of the Kentucky Department of Transportation and the official Comprehensive Plan, but shall not contain a right-of-way width less than 30 feet.
- ** Requirements will vary for a frontage road depending on whether the street would serve as a Local, Subcollector or Collector type street and as such would be designed in accordance with the respective requirements of said streets.
- *** Except as may be permitted in Table 3 of these regulations.
- **** Descending centerline grades approaching the terminus of a cul-de-sac shall be reduced within a vertical curve to a maximum of four (4) percent unless determination is made by the planning commissions duly authorized representative that a steeper grade will provide adequate clearance for vehicles entering ascending driveways.

2. Existing Streets: Existing rights - of - way (i.e., public or private) and widths shall be determined from existing deeds or lots of record and other statutes or agencies establishing such widths. Subdivisions platted along existing streets shall dedicate additional right-of-way, if necessary, to meet the minimum street width requirements set forth in Section 6.0, Subsection D (1) of these regulations. Such dedication shall be in accordance with the following:

- a. At least the minimum right-of-way width shall be dedicated where the subdivision is on both sides of an existing street.
- b. When the subdivision is located on only one side of an existing street, one-half (1/2) of the required right-of-way width, measured from the centerline of the right-of-way, shall be dedicated. However, the owner or owners of such property shall not be required to dedicate more than one-half (1/2) of the required rights-of-way width.

E. Curves and Sight Distance Criteria:

- 1. Horizontal Curve: When there is a change in the alignment of a street along the centerline, a curve with a radius adequate to insure safe sight distance shall be constructed. The minimum radii of curves shall be:

STREET TYPE	MINIMUM CURVE RADIUS
Arterial	*
Collector	400 feet
Local or Subcollector	100 feet

- 2. Sight Distance: Minimum sight distance shall be as required on Tables 2A, 2B, and 2C.

3. Reverse Curves: A tangent of at least two hundred (200) feet for collector streets, shall be provided between reverse curves. No tangent shall be required for local and subcollector streets.

PROPOSED AMENDMENTS ADDENDUM 1 AS ADOPTED

TABLE 2A

**SIGHT DISTANCE FOR VEHICLES EXITING FROM ACCESS POINTS ONTO ADJACENT ROADS
D= DISTANCE ALONG MAJOR ROAD FROM ACCESS POINT TO ALLOW VEHICLE TO ENTER (FEET) SEE
ACCOMPANYING ILLUSTRATION IN TABLE 2C**

VEHICLE TYPE	20 MPH				30 MPH				40 MPH				50 MPH				60 MPH			
	2 LANE		4 LANE		2 LANE		4 LANE		2 LANE		4 LANE		2 LANE		4 LANE		2 LANE		4 LANE	
	DL	DR	DL	DR	DL	DR	DL	DR	DL	DR	DL	DR	DL	DR	DL	DR	DL	DR	DL	DR
Passenger Car	225	195	235	205	335	290	355	310	445	385	470	415	555	480	590	515	665	575	710	620

TABLE 2B

**LEFT TURN SIGHT DISTANCE FOR VEHICLES ENTERING ACCESS POINTS
S= SIGHT DISTANCE ALONG MAJOR ROUTE FOR VEHICLE TO SAFELY TURN LEFT INTO ACCESS POINT (FEET)
SEE ACCOMPANYING ILLUSTRATION IN TABLE 2C**

VEHICLE TYPE	20 MPH			30 MPH			40 MPH			50 MPH			60 MPH		
	2 Lane	4 Lane	6 Lane	2 Lane	4 Lane	6 Lane	2 Lane	4 Lane	6 Lane	2 Lane	4 Lane	6 Lane	2 Lane	4 Lane	6 Lane
	Passenger Car	165	180	195	245	265	290	325	355	385	405	445	480	490	530

Notes: Intersection Controls shown are limited to Left and Right turns from a stop along a minor roadway; and, Left turns from a stop along a major roadway only. The Table values have been calculated and rounded for design based upon sight triangles using AASHTO - Geometric Design of Highways and Streets, Fourth Edition, 2001. AASHTO formula for Sight Distance. Left (DL) or Distance Right (DR) = 1.47 x Design or Prevailing Regulatory Speed (major road) x Time Gap. Time Gaps designated for Passenger Cars crossing lanes are as follows: 7.5 seconds - Left Turn from a Stop; and 6.5 seconds - Right Turn from Stop (Table 2A); and, 5.5 seconds - Left Turn from a Stop (Table 2B). Time Gaps are for a stopped vehicle turning left or right onto a two (2) lane roadway with no median and grades of three (3) percent or less. Table values require adjustments as follows; For left turns onto or from multiple - lane roadways with more than two (2) lanes, add 0.5 seconds for Passenger Cars for each additional lane to be crossed by the turning vehicle.

For minor roadways, if the approach grade ascends greater than three (3) percent, add 0.2 seconds for each percent grade for left turns and 0.1 seconds for right turns.

In applying the Table, calculated values are for Passenger Cars. Where substantial volumes of heavy vehicles enter these roadways, the use of other Time Gap Values for single - unit and combination trucks must be considered. These values are published in the AASHTO Design Standards.

TABLE 2C

SIGHT DISTANCE FOR VEHICLES EXITING FROM ACCESS POINTS
(refer to Table 2A)

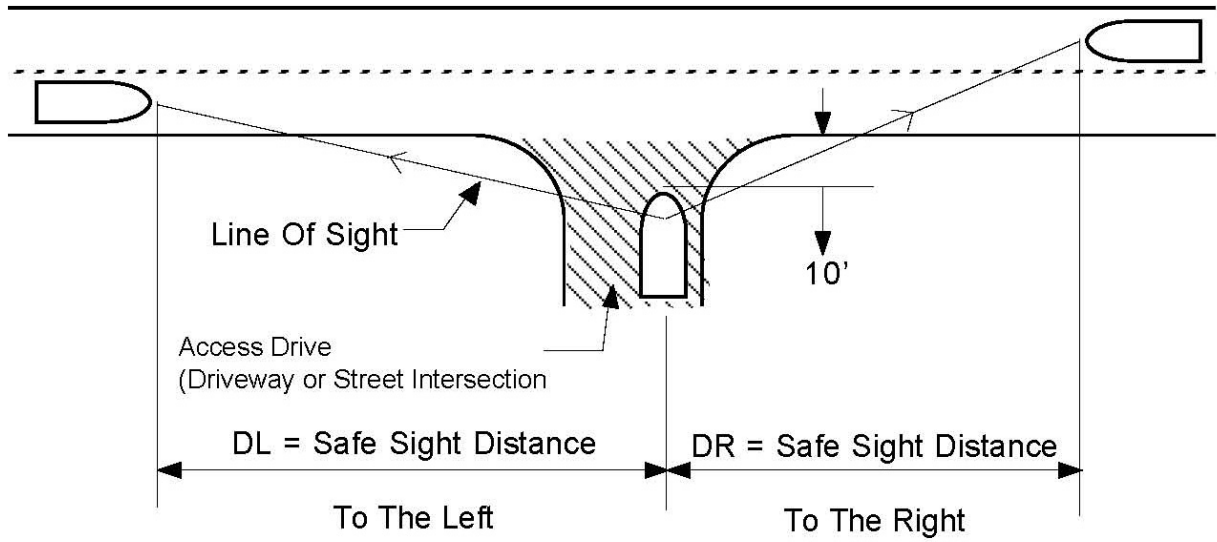

LEFT TURN SIGHT DISTANCE FOR VEHICLES ENTERING ACCESS POINTS
(refer to Table 2B)

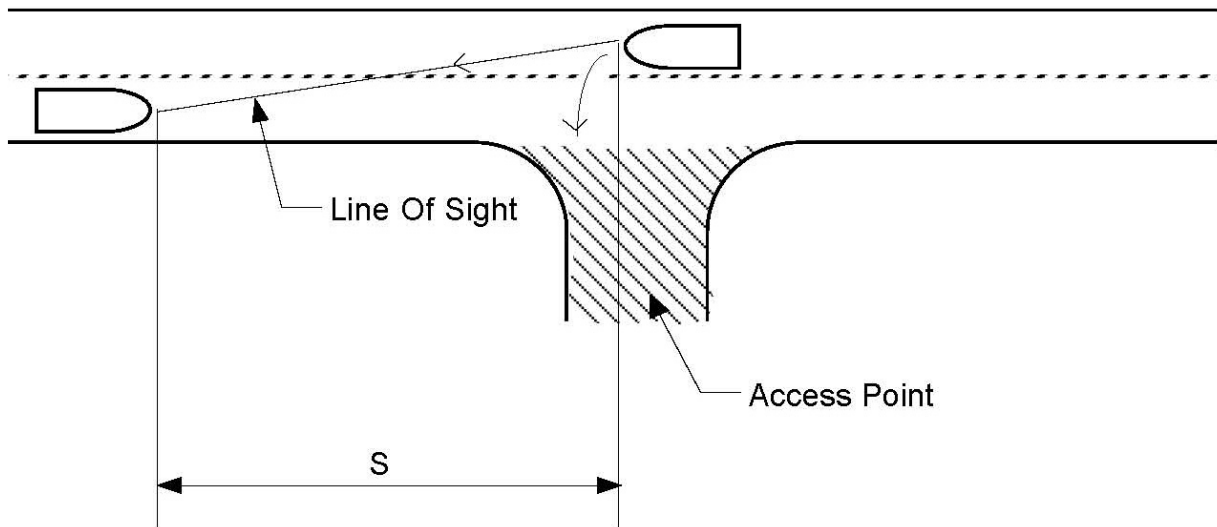

4. Vertical Curves: The minimum vertical curve length required shall be calculated by multiplying the algebraic difference in grades times a "K" factor. Rounded "K" factors for local and subcollector and collector streets are as follows:*

Local	--	K=15 for crest curves
and		
Subcollector	--	K=15 for sag curves
Collector	--	K=30 for crest curves
		K=35 for sag curves

* Design of arterial streets shall be based on current standards of the Kentucky Department of Transportation.

- F. Cul-De-Sac and Dead-End Streets: Cul-de-sacs and dead-end streets designed to be dead-end permanently, shall not be longer than 1,200 feet, unless local topographic or other physical conditions are such as to render these provisions impracticable.

G. Street Names and Addressing:

1. Duplication: The name of a new street shall not duplicate existing or platted street names within the county, or approximate such names in spelling, sound or pronunciation. The use of existing street names differentiated by alternate prefixes (i.e. "North", "South", etc.), or suffixes (i.e. "Lane", "Way", etc.) is prohibited. Street names shall not be objectionable or offensive. Street names shall be limited to no more than three (3) words including the suffix and contain no more than 20 characters including spaces. Punctuation, such as apostrophes or hyphens, etc., or numerals including fractions shall not be used as a part of any street name.
2. Continuation of Streets: New street names shall bear the same name of any continuation of, or when in alignment with, an existing or platted street, wherever practicable.
3. Street Names: All street names shall be approved and/or reserved by the planning commission's duly authorized representative, prior to approval of Improvement Drawings and Specifications.
4. Addressing: Where new streets are proposed, addressing for building development shall conform to a uniform county system and be assigned by the planning commission's duly authorized representative prior to approval of the Final Plat. Where improvements are not proposed or required, such addressing shall be assigned prior to approval of a final plat or identification plat. All addressing including numbers and street names

shall be shown for each lot or unit on Final Plats and Identification Plats for public record and distribution.

H. Alleys:

1. Alleys shall be prohibited in residential zoning districts, unless otherwise approved by the planning commission, or its duly authorized representative.
2. In commercial and industrial areas, adequate alleys shall be provided where the design requires. Alleys shall not serve as part of the required off-street parking, loading and/or unloading space required by the applicable zoning ordinance.

I. Private Streets:

1. Private streets or alleys shall not be created or extended, except as approved by the planning commission, and existing ones shall, whenever practicable, be dedicated to the public. Private streets, when approved, shall be designed, constructed and inspected in accord with same minimum specific standards for public streets, per Section 7.3 and other applicable sections of these regulations.

SECTION 6.1 INTERSECTIONS:

- A. **Angle of Intersection:** The centerline of all streets shall intersect as nearly at a ninety (90) degree angle as possible, but in no case shall the angle of intersection be less than seventy-five (75) degrees or greater than one hundred five (105) degrees, unless a special modification is granted by the planning commission due to certain exceptional conditions.
- B. **Centerline Offset of Adjacent Intersections:** Where T-intersections are used, the following minimum centerline offsets of adjacent intersections shall be as follows:

TYPE OF STREET	MINIMUM CENTERLINE OFFSET OF ADJACENT INTERSECTIONS IN FEET
Local - Local	150
Local - Subcollector	150
Subcollector - Collector	150
Collector - Collector	200

- C. **Corner Radii:** Property lines at street intersections shall be provided from the same radius point necessary to establish the pavement radius. If because of certain exceptional conditions, a modification is granted permitting an angle of intersection less than seventy-five (75) degrees, or greater than one hundred five

(105) degrees, then the minimum radii shall be increased or decreased, respectively.

- D. **Centerline Grades Within Intersections:** Maximum centerline grades within street intersections shall not exceed the grade for through streets, as identified in Table 1 of these regulations, depending on the type of street. The maximum grade of the centerline of the side streets intersecting with the gutter line of the through street shall not exceed four percent for a distance of not less than 75 feet from the center-line for local and subcollector streets and 150 feet for collector streets.
- E. **Design Adjacent to Freeways, Expressways, Arterials or Collectors:** The following principles shall be used in the design of subdivisions adjacent to freeways, expressways, or arterials:
 - 1. Street Design shall have the purpose of making adjacent lots desirable by cushioning the impact of heavy traffic and of minimizing the interference with traffic on such thoroughfares.
 - 2. Collector, Subcollector, and Local streets shall not be permitted to intersect with freeways or expressways. The number of intersections with arterial streets shall be held to a minimum and no new intersection of any kind shall be spaced less than 600 feet from any other intersection of any kind along the same side of the arterial street. In the case of collector streets, no new intersection of any kind shall be spaced less than 200 feet from any other intersection of any kind along the same side of the collector street. At those access points where turning vehicles to and from the arterial and collector streets will affect the roadway capacity or safety, reserved turn lanes shall be required. Frontage or service roads shall be used when these spacing requirements cannot be met.
 - 3. Where frontage roads are not required, lots adjacent to such thoroughfares shall, when practical, be served and be accessible only by a street generally paralleling said thoroughfare or by a series of cul-de-sacs or loop streets extending towards said thoroughfare from an internal street system.

SECTION 6.2 EASEMENTS:

- A. **Utility Easements:** Public utility easements at least Fifteen (15) feet in length width may be required along the front, rear, and sides of lots where needed for the accommodation of a public utility, drainage, or sanitary structures, or any combination of the foregoing. Where deemed necessary by the planning commission's duly authorized representative, an additional easement width shall be provided.

- B. Watercourses: The subdivider shall dedicate rights-of-way or provide easements for storm drainage purposes which conform substantially with the lines of any natural watercourses, channels, streams, or creeks which traverse the subdivision or for any new channel which is established to substitute for a natural watercourse, channel, stream, or creek. Such rights-of-way or easements shall be of a width which will provide for the maintenance needs of the channel as determined by the planning commission's duly authorized representative.

SECTION 6.3 PHYSICAL CONSIDERATIONS:

- A. Natural Land Use: Wherever practical, subdivisions shall be planned to take advantage of the natural topography of the land, to economize in the construction of drainage facilities, to reduce the amount of danger, to minimize destruction of trees and topsoil, and to preserve such natural features as watercourses, unusual rock formations, large trees, sites for historical significance, and other assets which, if preserved, will add attractiveness and value to the subdivision and the community.

SECTION 6.4 FLOOD HAZARDS:

- A. Prohibition of Development in Areas Susceptible to Flooding: Land subject to flooding or otherwise uninhabitable shall not be platted for residential, commercial, or industrial uses or for any other use which may increase the danger of health, life, property, or aggravate erosion or flood hazards. Such land within the subdivision shall be set aside on the plat for such uses as will not be endangered by periodic or occasional inundation or will not result in conditions contrary to the public welfare (e.g., use as open space, extensive recreation use, conservation purposes).
- B. Areas of land adjacent to streams, rivers, or bodies of water which have a high degree of susceptibility to flooding shall be limited to development according to the following regulations, notwithstanding any other section of the zoning ordinance or any other ordinance adopted by the county.
 - 1. The limits of the floodplain (areas subject to flooding during the occurrence of a 100 - year flood) and floodway are identified as Flood Protection Control Areas on the Official Zoning Map, pursuant to the Flood Insurance Study prepared by the Federal Emergency Management Agency. This study, along with any accompanying maps and other supporting data, and any revisions thereto are adopted by reference and declared to be a part of the zoning ordinance and these regulations.
 - 2. Areas designated as susceptible to flooding during the occurrence of a 100 - year flood are further regulated by Article VII of these regulations.

Flood data pursuant to the Flood Insurance Study identify the elevation of the 100 - year flood level and the width of the floodway. Reference to mapping and other supporting data is necessary.

In the case of proposed subdivisions located along other tributaries or bodies of water not covered in this study, stormwater drainage systems are further regulated by Article VII of these regulations.

3. No person, city, county, or other political subdivision of the state shall commence filling of any area with earth, debris, or any other material, or raise the level of any area in any manner, or place a building, barrier, or obstruction of any sort on any area including making any alteration or relocation of a waterway located within the floodway which would result in any increase in flood levels during the occurrence of a 100 - year flood discharge. In those cases where a watercourse is to be altered or relocated, the flood carrying capacity of said portion of the waterway affected must be maintained. Plans and specifications for such work shall be submitted to the planning commission's duly authorized representative for review to determine if such encroachment will meet the requirements of these regulations. Said plans shall also be submitted to the Kentucky Department of Natural Resources & Environmental Protection, Division of Water Resources, and other applicable agencies, for their review and approval, where required.
4. All land outside the floodway of the bodies of water identified in Subsection B.2. above but located within the floodplain, may be used, provided that:
 - a. Any new residential construction, including any expansion or substantial improvements of existing residential structures as herein defined, within said floodplain shall have the lowest floor elevated to or above the level of the 100 - year flood. Electrical, heating, ventilation, plumbing, and air conditioning equipment, and other service facilities shall be designed and/or located so as to prevent water from entering or accumulating within the components during conditions of flooding. For all new construction and substantial improvements, fully enclosed areas below the lowest floor that are usable for parking of vehicles, building access, or storage in an area other than a basement, and which are subject to flooding, shall be designed to automatically equalize hydrostatic exit of floodwaters. Designs for meeting this requirement must be certified by a professional engineer or architect.
 - b. Any new non - residential structures including any expansion or substantial improvements of non - residential structures within said floodplain, shall have the lowest floor elevated to or above the level of the 100 - year flood or together with attendant mechanical, utility and sanitary facilities shall be designed and floodproofed so that below the 100 - year

flood level the structure is water tight with walls impermeable to the passage of water and with structural components having the capability of resisting hydrostatic and hydro - dynamic loads and effects of frequency certified by a professional engineer or architect. For all new construction and substantial improvement and elevated non - residential structures fully enclosed below the lowest floor that are usable solely for parking of vehicles, building access or storage in an area other than a basement and which are subject to flooding shall be designed to automatically equalize hydrostatic flood forces on exterior walls by allowing for the entry and exit of floodwaters. Designs for meeting this requirement must be certified by a professional engineer or architect.

5. All streets and utilities constructed to serve the subdivision to be located within the floodplain, but which are outside the floodway, shall be: (a) flood protected; (b) the land filled; or (c) any combination thereof, to a level of not less than the elevation of the 100-year flood level. Where the fill is partially within the floodplain, roadway access and utilities shall be provided from the "dry" side (areas located above the 100-year floodplain).
- C. Stream Easement: If a stream flows through, or is adjacent to, the proposed subdivision, the plat shall provide for a storm water easement or drainage right-of-way along the stream for a floodway of at least fifteen (15) feet. For the smaller streams, the plat shall provide for channel improvement to enable them to carry all reasonable floods within banks. The floodway easement shall be wide enough to provide for future enlargement of the stream channels as adjacent areas become more highly developed and run-off rates are increased.
- D. Streets: Approval shall not be given for streets within a subdivision which would be subject to flooding. All streets must be located at elevations above a flood of a 100-year frequency in order that no portion of the subdivision would become isolated by floods, except that where a secondary access is provided which would be above a 100-year flood frequency. However, streets may be permitted in areas subject to flooding of a 100-year frequency provided said streets provide access to activities relating to rivers, streams, and recreational activities located along said areas.

SECTION 6.5 BLOCKS:

- A. Arrangement: The arrangement of blocks shall be such as to provide for convenient access, circulation, control and safety of street traffic. Blocks intended to be used for commercial or industrial purposes shall be designed specifically for such uses with space set aside for off-street parking and loading and/or unloading facilities as required by the applicable zoning ordinance.

- B. Length: Blocks should not exceed twelve hundred (1,200) feet, except where topographical or exceptional physical conditions exist.
- C. Width: The width of blocks should ordinarily be sufficient to allow for two (2) tiers of lots except for double frontage lots, as permitted in Section 6.6 of these regulations.

SECTION 6.6 LOTS:

- A. Every proposed lot shall front at least 15 feet onto a publicly dedicated street. The planning commission may grant a waiver to the frontage requirement for lots proposed to be subdivided from a tract of land in the same ownership that existed on the effective date of these regulations provided the planning commission shall find:
 - 1) That the proposed lot(s) are large, rural estate type lots; and
 - 2) That the proposed lot(s) are consistent with the rural characteristic of the surrounding area; and
 - 3) That access to the lot(s) is provided via a vehicular passway within a legally recorded permanent ingress and egress easement that safely and effectively circulates vehicular traffic; and
 - 4) That the vehicular passway providing access to the lots is a minimum of 12 feet wide; and
 - 5) That requiring the proposed lot(s) to front onto a publicly dedicated street would create an extraordinary hardship on the applicant(s).
- B. Each lot proposed for residential building development in areas not served by a public sanitary sewerage system shall be a minimum of one (1) acre in size, contain a minimum lot width at the building setback line of 100 feet, and be capable of supporting an on site sewage disposal system approved by the Pendleton County Health Department.
- C. Lots shall not be laid out so that they have frontage onto more than one (1) street except: (a) when the lots are adjacent to the intersection of two (2) streets; or (b) when the rear of the lot faces an arterial, freeway, expressway, collector street, railroad right-of-way, etc., and the front of the lot faces onto another street.
- D. All subdivisions shall result in the creation of lots which are developable and capable of being built upon. No lots may be developed which create building sites which are impracticable to improve due to known problems related to soil conditions and geological formations and areas subject to flood prone conditions based on information prepared by the U.S. Soil Conservation Service, Geological survey maps prepared by the U.S. Geological Survey, and flood prone

information supplied by the U.S. Army Corps of Engineers and the U.S. Geological Survey.

SECTION 6.7 PEDESTRIAN WAYS: Where deemed necessary by the planning commission's duly authorized representative, pedestrian ways may be required, and if provided, they should not exceed a fifteen (15) percent grade, unless steps of an acceptable design, as determined by the planning commission's authorized representative, are to be constructed.

SECTION 6.8 PUBLIC SITES: Where a proposed park or other recreational area, school site, or other public ground identified in the adopted Pendleton County Comprehensive Plan, is located in whole or in part within the proposed subdivision, the planning commission, or its duly authorized representative may require a reservation, as a condition precedent to preliminary plat approval, not to exceed two (2) years, for the purchase of such public ground by the applicable public body.

**ARTICLE VII
INFRASTRUCTURE IMPROVEMENTS**

This article establishes standards for the design of improvements for all land uses as a part of subdivisions or other developments within the county. Improvements for primary and other infrastructure include stormwater drainage systems, sanitary sewer systems, water systems, streets, driveways and sidewalks, utilities and other related systems. All plans for improvements must be designed by a Registered Professional Engineer, reviewed, approved, constructed and inspected by the planning commission's duly authorized representative and/or other regulatory agencies, where applicable, in accord with provisions of these regulations.

SECTION 7.0 STORM WATER DRAINAGE SYSTEMS

A. GENERAL

1. This section establishes the criteria, methodology, minimum standards and specifications for design of all components of a storm drainage system. Such components may include the following systems: a) open systems (i.e. rivers, streams, creeks, channels, linings, side ditches, inlets, street curb and gutter, etc.); b) closed systems (i.e. bridges, box culverts, sewer pipe, manholes, junction boxes, etc.); c) impoundments (i.e. lakes, ponds, detention/retention basins, underground vaults, etc.); or d) combinations of open and closed systems or impoundments as an internal part of the storm drainage system.
2. Design criteria for subdivision development shall apply to all storm drainage systems within areas shown on a Preliminary Plat. Such designs must include local systems impacted by “direct runoff” from the site and extra - sized systems for “through runoff” stormwater drainage emanating from other developed or undeveloped land uses within the drainage area.
3. Any development adjacent to other facilities (i.e, floodplain, streams, highways, county roads, etc.) under the jurisdiction of federal, state and/or local governmental agencies must be “Permitted” by these agencies prior to final approval by the planning commission or its duly authorized representative for construction. In these cases, the following approvals must be obtained, where applicable.

B. EXEMPTIONS

1. The following activities are specifically exempted from these regulations:
 - a. Land disturbing activities on property used for agricultural, horticultural, or botanical production of plants and animals useful to man, including but not limited to: forages and sod crops, grains and feed crops, tobacco, cotton, and peanuts; dairy animals and dairy products; poultry and poultry products; livestock, including beef cattle, sheep, swine, horses, ponies, mules, or goats, including the breeding and grazing of these animals; bees; fur animals and aquaculture, except that the construction of a structure used for agricultural purposes of one

or more acres, such as broiler houses, machine sheds, repair shops and other major buildings shall require the submittal and approval of a storm water management plan prior to the start of the land disturbing activity.

- b. Land disturbing activities undertaken on forest land for the production and harvesting of timber and timber products.
- c. Minor land disturbing activities such as residential gardens, individual residential or commercial landscaping, minor home repairs, or maintenance work, and construction or maintenance of individual underground utility connections.
- d. Activities undertaken by local governments or special purpose or public service districts relating to the emergency repair and maintenance of existing facilities and structures. These activities will be carried out using appropriate best management practices to minimize the impact on the environment and surrounding properties.

C. DESIGN CRITERIA AND METHODS

1. DESIGN STORMS

The storm water conveyance system shall be designed to adequately handle the runoff from storms having various frequencies of occurrence from different types of development in accordance with the following general categories. To ensure the adequacy of the storm water conveyance system, the following design storms shall be used, where applicable:

- a. The 10-Year Storm shall be used for all residential, commercial, institutional, and industrial uses and public facilities. Local drainage systems (i.e., inlets and closed pipe systems, etc.) for "direct runoff" shall be designed to collect and transport the post-development rate of runoff unless damaging flooding or surcharging occur when more frequent recurrence interval storms are selected;
- b. The 25-Year Storm shall be used for all open channels and for sewer systems designed for a 10-Year Storm as a Check Storm to further ensure against damaging flooding or surcharging where public access emergencies or severe property losses will occur;
- c. The 2, 10, 25 and 50-Year Storms shall be used to calculate pre-development runoff from a site for detention, retention, and sediment control basins;
- d. The 2, 10, 25, and 50-Year Storms shall be used to determine post-development discharges for detention, retention, or sediment control basins;

- e. The 100-Year Storm shall be used for all detention, retention, or sediment control basins as a Check Storm to ensure against damaging flooding or surcharging where public access emergencies or severe property losses will occur;
- f. The 100-Year Storm shall be used in the design of flood control facilities;
- g. The 100-Year Storm shall be used in comparison with established flood elevations from property owners, observations, KDOT drainage folder data, FEMA maps and other viable records to minimize the impacts of flooding and storm water;
- h. Localized restrictions may be placed on some areas where pre-existing downstream problems or hydrologic and hydraulic models developed for the area exist. Conditions for design in such cases shall be as required by the Planning Commission's duly authorized representative.

Table 1: Summary of Design Storm Requirements

Storm Frequency	Local Drainage	Storm Water Management Control Facilities	Flood Control
2		Design (Pre & Post Development)	
10	Design Storm	Design (Pre & Post Development)	
25	Design Storm / Check Storm	Design (Pre & Post Development)	
50		Design (Pre & Post Development)	
100		Check Storm	Design Storm

2. **RUNOFF COMPUTATION METHODS**

- a. Numerous methods of rainfall-runoff computation are available on which the design of storm drainage and flood control systems may be based. The Rational Method and the Soil Conservation Service hydrologic methods (available in TR-20, TR-55, and HEC-1) are accepted as adequate for determining peak runoff rates for drainage areas totaling 100 acres or less.
- b. For larger drainage systems, the Soil Conservation Service hydrologic methods or the "Regional Method" of the Kentucky Transportation Cabinet, Bureau of Highways shall be used to determine peak runoff rates. The method of analysis must remain consistent when drainage areas are combined. The method which applies to the largest combined drainage area should be used. The engineer can use other methods but must have their use approved by the Planning commission's duly authorized representative.

- c. The Modified Rational Method (MRM) may be used for design of storm water control facilities with a contributing drainage area to a storm water control facility of ten (10) acres or less.

3. RATIONAL METHOD

- a. The Rational Method may only be used to calculate peak discharge rates for drainage areas of 100 acres or less. The Rational Method shall not be used to calculate the volume of storm water runoff or develop runoff hydrographs.

$$Q = CiA$$

where:

Q = peak runoff quantity in cubic feet per second;

C = runoff coefficient varying with the amount of imperviousness and other characteristics of the drainage area. Table 2 presents ranges for "C" values based on specific land use types;

i = average intensity of precipitation in inches per hour, varying with frequency of storm occurrence, duration or concentration time, and area of the tributary watershed; and

A = area in acres of the tributary watershed.

- b. The proportion of the total rainfall that will reach the drainage system depends on the imperviousness of the surface and the slope and ponding characteristics of the area. Impervious surfaces, such as asphalt pavements and roofs of buildings, will be subject to approximately 100 percent runoff (regardless of the slope). On-site inspections and aerial photographs may prove valuable in estimating the nature of the surfaces within the drainage area.
- c. The runoff coefficient "C" in the Rational Formula is also dependent on the character of the soil. The type and condition of the soil determines its ability to absorb precipitation. The rate at which a soil absorbs precipitation generally decreases as the rainfall continues for an extended period of time. The soil infiltration rate is influenced by the presence of soil moisture (antecedent precipitation), the rainfall intensity, the proximity of the ground water table, the degree of soil compaction, the porosity of the subsoil, and ground slopes.
- d. It should be noted that the runoff coefficient "C" is the variable of the Rational Method that is least susceptible to precise determination. A reasonable coefficient must be chosen to represent the integrated effects of infiltration, detention storage, evaporation, retention, flow routing

and interception, all of which affect the time distribution and peak rate of runoff.

- e. Rainfall intensity (i) is the average rainfall rate in inches per hour, and is selected on the basis of design rainfall duration and design frequency of occurrence. The design duration is equal to the time of concentration for the drainage area under consideration. The design frequency of occurrence is a statistical variable that is established by design standards or chosen by the engineer as a design parameter.
- f. The rainfall intensity used in the rational method is read from the intensity-duration-frequency curves based on the selected design frequency and design duration. The values of precipitation intensity in inches per hour, for Cincinnati, can be extrapolated from Exhibit No. 2-504.5 Kentucky Bureau of Highways "Rainfall Intensity-Duration-Frequency Curves" or other sources acceptable to the Planning commission's duly authorized representative.

4. TIME OF CONCENTRATION

The time of concentration is the time associated with the travel of runoff from an outer point that best represents the shape of the contributing areas. Runoff from a drainage area usually reaches a peak at the time when the entire area is contributing, in which case the time of concentration is the time for a drop of water to flow from the most remote point in the watershed to the point of interest. Runoff may reach a peak prior to the time the entire drainage area is contributing. Sound engineering judgment should be used to determine the time of concentration. The time of concentration to any point in a storm drainage system is a combination of the sheet flow (overland), the shallow concentrated flow and the channel flow, which includes storm sewers. The minimum time of concentration for any area shall be 6 minutes.

5. TIME OF CONCENTRATION CALCULATIONS

The Soil Conservation Service TR-55 method for calculating the time of concentration shall be used.

<i>Table 2 - Rational Method Runoff Coefficients for Composite Analysis</i>		
Land Use Description	Average Percent Imperviousness	Runoff Coefficient (C)
Natural and Undisturbed Areas	Varies	0.4
Single Family Residential	Varies	0.43-0.76
Average Lot Size/Width	(See Below for Value)	(See Below for Value)
3 acres/300 feet	6	0.43
2 acres/200 feet	7	0.44
1 acre/100 feet	12	0.47
1/2 acre/100 feet	23	0.53
12,500 sq. ft./80 feet	34	0.59
9,000 sq. ft./70 feet	42	0.63
8,500 sq. ft./60 feet	44	0.64
6,000 sq. ft./50 feet	48	0.66
<6,000 sq. ft./<50 feet	65	0.76
Industrial	72	0.80
Multi-Family Residential	75	0.81
Commercial/Office	85	0.87
Impervious Areas Including; Pavement, Roofs, Drives, Sidewalks, etc.	100	0.95

6. **RUNOFF COEFFICIENTS**

Runoff coefficients (C) for the land uses shown in Table 2 must be used unless actual impervious areas are calculated and composite (C) factors are determined and submitted. When Composite (C) factors are used, impervious areas with a C = 0.95 and all other areas with a C = 0.40 shall be used. In no case shall post-development runoff coefficients be less than pre-development runoff coefficients.

7. **SOIL CONSERVATION SERVICE METHOD**

The Soil Conservation Service (SCS) Method may be used to calculate the peak discharge rates; develop runoff hydrographs for basins and subbasins; determine runoff volumes; and provide inflow information to determine the required storage volume for detention and retention basins. The SCS Method is the preferred method for performing hydrologic analysis. The SCS Method will utilize the formulas, constants and data in the current manual from the U.S. Natural Resources Conservation Service. The Soil Conservation Service utilizes a 24-hour storm duration, which is considered to be acceptable for Northern Kentucky. When the Soil Conservation Service methods are used, the Type II rainfall distribution shall be used. For detailed information, the user is referred to the following Soil Conservation Service publications:

- a. NEH-4: "Hydrology," Section 4, National Engineering Handbook;

- b. TR-20: Computer Program for Project Formulation, Hydrology;
 - c. TR-55: Urban Hydrology for Small Watersheds;
 - d. TP-149: A Method for Estimating Volume and Rate of Runoff in Small Watersheds.
8. **KENTUCKY TRANSPORTATION CABINET REGIONAL METHOD**
The Regional Method of the Kentucky Transportation Cabinet, Bureau of Highways (Regional Method) may be used to calculate the peak discharge rates when required by regulatory agencies such as the Kentucky Division of Water. The Regional Method will utilize the formulas, constants and data from the current Manual of Instruction of Drainage and Design, Kentucky Transportation Cabinet, Bureau of Highways.
9. **MODIFIED RATIONAL METHOD**
The Modified Rational Method (MRM) may be used for design of storm water control facilities. The maximum contributing drainage area to a storm water control facility designed with the MRM is ten (10) acres. If the Modified Rational Method is used by computer program, the storm duration used shall be the one that produces the maximum storage. If calculating by hand, the duration shall be greater than the time of concentration.

D. DESIGN OF STORM SEWERS

1. **PURPOSE OF STORM SEWERS**
Storm sewer systems are designed to collect and convey storm water runoff from street inlets, runoff control structures, and other locations where the accumulation of storm water is undesirable. The objective is to remove runoff from an area fast enough to avoid unacceptable amounts of ponding damage and inconvenience.
2. **PEAK DISCHARGE CALCULATIONS**
The method of runoff calculation for determining peak discharge (Q) for a drainage area shall be the methods described in Section 302.
3. **SEWER FLOW TIMES**
Flow times in sewers or conduits to the point of design may be determined from the hydraulic properties of the sewers upstream of that point, assuming average flow-full velocity at the proposed sewer slopes.
4. **STORM SEWER DESIGN**
Public storm sewer pipes shall be designed to carry peak flows as determined by the methods previously described. For the design storm, the drainage system shall be designed as open channel (non-surcharged) flow. Sizes shall be determined by Manning's formula using a range of roughness coefficients (N=0.009 - 0.024).

5. **MINIMUM PIPE SIZES**
The minimum diameter for public storm sewer pipe shall be 15 inches for inlet headwalls and 12 inches for systems with a catch basin at the initial point.
6. **PIPE VELOCITIES**
Velocities in public storm sewer pipes, when flowing full at average peak flows, shall not be less than 2.0 feet per second. Velocities shall be non-erosive at the re-entrance into the natural stream or downstream channel. The downstream receiving channel or stream must receive adequate protection against erosion through the use of erosion prevention practices or energy dissipation devices if the storm sewer discharge would cause erosion. The outlet velocities of all headwalls shall be included in the drainage calculations.
7. **PIPE GRADES**
Storm sewer pipe shall be laid on gradients so that the velocity (flowing full) shall be kept within the foregoing stated minimum and maximum, unless other special provisions are made. Sewers on 20 percent slopes or greater shall be anchored securely with concrete anchors or equal, spaced as follows:
 - a. Not over 36 feet center to center on grades 20 percent and up to 35 percent;
 - b. Not over 24 feet center to center on grades 35 percent and up to 50 percent; and
 - c. Not over 16 feet center to center on grades 50 percent and over.
8. **HYDRAULIC GRADE LINES**
To ensure against surface ponding or street flooding, due to surcharging, the hydraulic grade line (HGL) in any inlet or manhole may not be higher than the inlet grade. The HGL for the 10-Year Design Storm and 25-Year Check Storm shall be shown on all profiles of the storm water system.
9. **REDUCTION OF PIPE SIZE**
Design of all public storm sewer appurtenances shall consider the balance of energy plus the loss due to entrance in all structures having a critical change in horizontal or vertical alignment. In no case shall the difference in invert elevations be less than the result of equal crowns when a smaller pipe empties into a larger one. In no case shall storm sewer pipe sizes be reduced more than one standard increment of pipe diameter due to an increase in invert gradient after balancing the energy losses within the structure.
10. **MANHOLES**
Manholes shall be constructed in accord with Standard Construction Drawings as shown in Appendix "C".
11. **DROP MANHOLES**

Drop manholes may be required to reduce the slope of any sewer that has a velocity that exceeds 20 feet per second. Pipes shall not extend more than 2 inches into the side of the manhole, and the invert of the outlet pipe shall be at the bottom.

12. INLETS

a. Capacity:

The capacity of on-street inlets should not be less than the quantity of flow tributary to the inlet. Inlets at low points or sags should have extra capacity as a safeguard for street flooding from flows overtopping the street curb. Curb openings or combination inlets should be used for overflows in the event that the grate is clogged. Special inlets may be required for streets with steep gradients to provide the extra capacity such situations require. Where avoidable, inlets should not be placed along streets where driveways and/or aprons conflict with mountable roll or depressed curbing. The 10-Year Design Storm return period shall be used to design storm water inlets. Curb inlets and gutters shall approximate a storm intensity of four (4) inches per hour. Design methodology utilized should be similar to those presented in manuals produced by the Kentucky Transportation Cabinet or other manuals approved by the Planning commission's duly authorized representative.

b. Type:

(1) On - street combination type inlets (single or double) shall be used and installed in accord with "Standard Construction Drawings" as shown in Appendix "C", or approved equal.

(2) Off - street type inlets shall be used and installed in accord with "Standard Construction Drawings" as shown in Appendix "C", or approved equal. Where pipe openings are 24 - inches and less, types of inlets used shall be those defined as yard drain, sloped and flared box inlets and/or sloped box inlets type 1 or approved equal. Standard and/or wing walled type headwalls serving pipes 24 - inches and smaller are prohibited for use as inlets unless provided with enclosure grates in accord with these regulations. Except for inlets serving temporary silt basins, detention and/or retention basins or pipes or other openings greater than 24 - inches, the maximum dimension of opening on all storm water inlets shall be limited such that a sphere with a diameter of 6-inches cannot pass through any opening.

c. Location:

(1) Inlet spacing along streets shall be based upon gutter and inlet capacity, street slope, and contributing drainage area. The spacing of inlets should ensure that street drainage generated along continuous grades or in sags will not flood and damage private properties or residential basements. In general, the spacing of combination inlets

shall not exceed the following requirements, unless detailed hydraulic computations indicate otherwise and are submitted with Improvement Drawings and Specifications:

- (a) Along continuous grades (less than two percent) - 400 feet maximum;
 - (b) Along continuous grades (two percent and over) - 600 feet maximum;
 - (c) At sag locations (draining less than two percent grades) - 400 feet maximum between inlets or from a high point;
 - (d) At sag locations (draining two percent and over grades) - 600 feet maximum between inlets or from a high point;
 - (e) Inlets shall be placed immediately upstream of pedestrian walkways and designed to intercept 100% percent of the flow;
 - (f) Inlets placed at locations other than in (e) above shall be designed to intercept 75% of the flow; and
 - (g) Inlets for drains connected to the combined sewer system or/other systems having known Infiltration/Inflow problems should be designed with flow-throttling capabilities, if required.
- d. Special consideration should be given to storm drainage entering cul-de-sacs. Additional inlets shall be required when drainage areas and/or street slopes are excessive. In addition to an inlet provided near the low point within the cul-de-sac, two (2) additional inlets shall be required along each curb prior to the entrance of the cul-de-sac in accord with the following criteria:
- (1) For street slopes less than eight (8) percent and draining more than 400 feet of pavement; and
 - (2) For all street slopes more than eight (8) percent and draining more than 300 feet of pavement.

13. CAPACITY OF OFF-STREET YARD DRAINS

The capacity of the surface openings on off-street yard drains shall not be less than two (2) times the discharge 'Q' for a 10-Year Design Storm from the contributing drainage area to allow adequate discharge when debris accumulates. To improve safety at yard drains, ponding or headwater submerging such inlets shall not exceed a depth of 1.0 feet above the highest opening of any inlet at its surface for a 10-Year Design Storm. A 25-Year

Check Storm shall be used to further ensure against damaging flooding and property losses.

14. CAPACITY OF OFF-STREET INLETS

The capacity of off-street inlets with enclosure grates or other open headwalls or culverts shall not be less than two (2) times the pipe diameter above the invert where water would rise to a maximum level for a 10-Year Design Storm for improved safety. A 25-Year Check Storm shall be used to further ensure against damaging flooding and property losses.

15. STORM SEWER OUTFALLS

When a storm sewer system outfalls into a flood plain of any major watercourse, the outfall must not be subject to frequent floods or backwaters. Standard headwalls and/or headwalls with wingwalls including rock channel protection as aprons as erosion control, shall be constructed for all outfalls. Suitable baffles or other energy dissipaters shall be provided if maximum velocities are exceeded. The invert of the first storm sewer appurtenance upstream of the outfall structure shall be above the elevation of the calculated 100-year flood plain. The calculated 100- year flood plain for all channels with a drainage area of more than 50 acres within the land disturbing, development, or re-development activity shall be shown on the site plan.

16. CULVERTS AND BRIDGES

Culverts and bridges shall be designed in accordance with the methods given in the "Manual of Location and Design" published by the Kentucky Department of Highways; except that storm water quantities to be handled by the culverts and bridges shall be determined on the basis described in these standards. The allowable headwater (AHW) shall not be greater than $HW/D = 2.+$.

17. HEADWALLS AND SAFETY RAILINGS

- a. Except for driveway entrance pipe, headwalls or other structures shall be constructed at the inlet and outlet of all storm sewers in accord with "Standard Construction Drawings" as shown in Appendix "C". Concrete headwalls per Appendices C-24 and C-25 for pipe diameters 24 - inches and less shall be used for outlets only. Same sized headwalls are prohibited for use as inlets.
- b. Safety railings shall be provided along the top and sloped/winged side walls on all headwall inlet and outlet structures or other culverts or bridge structures having a vertical drop of 4' - 0" or greater. Such guards or railings shall be at least 42 - inches in height measured vertically above the walls. Openings in guards shall have balusters or ornamental patterns that do not provide or create a ladder effect such that a sphere with a diameter of four (4) - inches cannot pass through any opening, except for the top eight (8) - inches. Safety railings and attachments shall be made of materials that are weather resistant and ultraviolet (UV) light resistant adequate in strength to resist uniform, concentrated and impact loads in accord with the applicable sections of

the Kentucky Building Code, latest version. Safety railings constructed of wood are prohibited. In addition, the use of landscaping buffers does not qualify as an acceptable safety railing.

18. SPECIFICATIONS FOR CONSTRUCTION MATERIALS

In all other respects, the design, materials, and construction shall be as specified in Sections 601, 602, 610, 611, 612, 616, 704, 706, 709, 710, 737, "State of Kentucky Standard Specifications for Road and Bridge Construction", and in accord with "Standard Construction Drawings", shown in Appendix "C". Non-circular pipe may also be specified.

The following types of pipe shall be specified as a minimum for storm sewers, in accord with the following requirements:

a. Reinforced Concrete Pipe (RCP AASHTO M 170, ASTM C76 and AASHTO M198)

- (1) 27" - 120" Class II Wall A, B or C Max. Cover 11 feet;
- (2) 18" - 120" Class III Wall A, B or C Max. Cover 22 feet
- (3) 12" - 120" Class IV Wall A, B or C Max. Cover 36 feet.

Notes: (1) Minimum Class III shall be required beneath all street pavements or driveways.

(2) Design and installation shall be in accord with AASHTO Section 17 Soil-Reinforced Concrete Structure Interaction Systems, ASTM C12 or ACPA Design Data 40, where applicable, except that Pipe Bedding and Trench Conditions shall be per Appendix C.

b. Bituminous Coated Galvanized Corrugated (2-2/3" x 1/2") Steel Pipe (AASHTO M36 Type I, AASHTO M218 and AASHTO M190 Type A):

- (1) 12" - 36" 16 Gauge
- (2) 42" - 54" 14 Gauge
- (3) 60" 12 Gauge
- (4) 66" - 72" 10 Gauge

c. Bituminous Coated Galvanized Corrugated (3" x 1") Steel Pipe (AASHTO M36 Type 1, AASHTO M218, and AASHTO M190 Type A)

- (1) 36" - 90" 16 Gauge
- (2) 96" - 102" 14 Gauge
- (3) 108" - 120" 12 Gauge

d. Bituminous Coated Galvanized Spiral Rib (3/4" x 3/4" x 7-1/2") Pipe (AASHTO M36 Type I, AASHTO M218, and AASHTO M190 Type A):

- (1) 18" - 36" 16 Gauge
- (2) 42" - 54" 14 Gauge
- (3) 60" - 72" 12 Gauge

Note: Bituminous Coating within items b. thru d. shall be quality controlled by the manufacturer. Field coating of any pipe shall be prohibited. Bituminous coating not required for driveway entrance pipe.

- e. Aluminized Type 2 Corrugated (2-2/3" x 1/2") Pipe (AASHTO M36 Type 1, AASHTO M274)
 - (1) 12" - 36" 16 Gauge
 - (2) 42" - 54" 14 Gauge
 - (3) 60" - 12 Gauge
 - (4) 66" - 72" 10 Gauge

- f. Aluminized Type 2 Spiral Rib (3/4" x 3/4" x 7-1/2") Pipe (AASHTO M36 Type 1, AASHTO M274)
 - (1) 18" - 36" 16 Gauge
 - (2) 42" - 54" 14 Gauge
 - (3) 60" - 72" 12 Gauge

- g. Aluminum Spiral Rib (3/4" x 3/4" x 7-1/2") Pipe (AASHTO M196 and M197)
 - (1) 18" - 30" Gauge 14 Max. Cover 30 feet
 - (2) 36" - 48" Gauge 12 Max. Cover 30 feet
 - (3) 54" - 66" Gauge 10 Max. Cover 30 feet.

Notes: (1) All joints for corrugated and spiral rib pipe for items b. thru g. shall be special joints having bolt, bar and strap premium 'O' Ring Gasket connectors; (2) Design, installation and maximum height of cover (except as stated for item g.) shall be in accord with AASHTO Section 26 Metal Culverts except that Pipe Bedding and Trench Conditions shall be per Appendix C.

- h. Polyvinyl Chloride (PVC) Pipe
 - (1) Smooth Wall:
 - (a) Pipe/Fittings: ASTM D 3034; ASTM F679; AASHTO M 278
 - Material: ASTM D 1784
 - Joint: ASTM D 3212
 - Sizes: 12" - 27" or other size available
 - Minimum Pipe Stiffness: 46 @ 5% deflection
 - Installation: ASTM D 2321.

 - (2) Ribbed:
 - (a) Pipe/Fittings: ASTM F794; ASTM F949; AASHTO M304
 - Material: ASTM D 1784
 - Joint: ASTM D3212
 - Sizes: 12" - 48" or other size available
 - Minimum Pipe Stiffness: 46 @ 5% deflection
 - Installation: ASTM D 2321

(b) Pipe/Fittings: AASHTO M 304
Material: ASTM D 1784
Joint: ASTM D 3212
Sizes: 18" - 48" or other size available
Minimum Pipe Stiffness: Variable @ 5% deflection
Installation: ASTM D 2321.

i. Polyethylene (HDPE) Pipe

(1) Corrugated:

(a) Pipe/Fittings: AASHTO M294 Type S

Material: ASTM D 3350

Joint: Minimum silt tight including: (a) thermally molded; (b) integral bell; or (c) bell and spigot with built-in gasket coupler assemblies only.

Sizes: 12" - 30" only

Minimum Pipe Stiffness: Variable @ 5% deflection

Installation: ASTM D 2321.

NOTES: (1) Design, installation and maximum height of cover for items h. and i. shall be in accord with AASHTO Section 18 - "Soil - Thermoplastic Pipe Interaction Systems" except that Pipe Bedding and Trench Conditions shall be per Appendix C;

(2) Design engineer shall be required to submit a special design or additional documentation for any variation to minimum standards as stated above.

(3) Minimum height of cover for all pipe shall be 12-inches (measured from bottom of rigid or flexible pavement) except for aluminum conduits with diameters greater than 48 inches require 24 inches; (4) All pipe installations greater than 30-inches require full-time on-site inspections under the direction of a qualified Geotechnical Engineer or Firm.

E. DESIGN CRITERIA FOR STORM WATER DRAINAGE CHANNELS AND WATER COURSES

1. PURPOSE OF STORM SEWERS

Open channels provide many advantages in the management and control of storm water runoff. Such channels provide for natural infiltration of storm water into ground water supply and extend the Time of Concentration (Tc) helping to maintain the runoff rate nearer to that which existed prior to development. The objective of open channel flow design is: (a) to determine a channel slope and size that will have sufficient capacity to prevent undue flooding damage during the anticipated peak runoff period; and (b) to determine the degree of protection based on stream velocity to prevent erosion in the drainage channel. Existing drainage channels, which will remain

undisturbed, shall not be required to be reconstructed unless additional capacity and erosion control is required.

2. DESIGN STORMS

Storm water drainage channels and watercourses shall be adequate to handle runoff from storms of the frequencies of occurrence and duration shown for the degrees of site development as follows:

- a. For all developments - 25-Year Storm.
- b. For main flood control channels - 100-Year Storm frequency.
- c. The runoff computed from these storms shall be that from the area within the development or re-development.

3. PEAK FLOW CAPACITY

Each portion of the storm water system of drainage channels and water courses shall be capable of handling the peak flows as determined by the proper method previously described in Section C.

4. DRAINAGE CHANNEL CAPACITIES

Drainage channels shall be designed to carry peak flows as determined by the methods previously described. Channel cross-section areas shall be determined by Manning's formula, using a value of $n = 0.030$ for earth sections, $n = 0.020-0.025$ for aggregate linings, and $n = 0.015$ for paved sections.

5. CHANNEL LININGS

When open drainage channels require various lining types to attain ultimate design capacity, the earth sections of the drainage channel and its structure shall be designed and constructed to the ultimate design required. Lining will not be required in the initial construction and may be delayed until development of the area produces runoff quantities large enough to result in erosive channel flows, unless drainage channel velocities are excessive initially.

6. CHANNEL DESIGN VELOCITIES

Runoff flows in open channels may cause accelerated erosion. Such erosion can be controlled by limiting velocities, changing the channel lining, and reshaping the channel to spread the flow of runoff. Methods of controlling erosion in open channels include the following: (1) grass covers or sod; (2) Type II channel lining; and (3) reinforced concrete or pre-cast paving. Erosion control for drainage channels shall be provided as follows:

- a. Design velocities should generally be greater than 1.5 feet per second to avoid excessive deposition of sediments. When flat slopes are unavoidable, concrete paving should be used to accelerate runoff.
- b. When design velocities are between one (1) and one-half (1.5) and four (4) feet per second, the bottom and sides of the earth channel shall be seeded, mulched and fertilized to an elevation of three (3) feet above

the design water surface. Seeding shall be a perennial or annual mixture of grass seeds at a rate of 75 pounds per acre. Acceptable whole fertilizer shall be applied at a rate of 75 pounds per one thousand feet. On slopes over five (5) percent, the bottom and sides of the earth channel shall be sodded and pegged to remain in place. Where seeding or sodding is required and the soil is not capable of supporting vegetation (such as sandy soil or other clay types), appropriate action shall be taken to bring the soil to an acceptable condition which will support the growth of seed or sod.

- c. When velocities exceed four (4) feet per second, the bottom and sides of the earth channel shall be protected from erosion with an application of stone rip-rap, coarse aggregate and/or dumped rock channel linings. The type of application thickness and quantities shall be designed by the engineer to ensure maintenance-free permanent stabilization. Reinforced concrete pavement at least four (4) inches thick may also be used at bends, changes in alignment, junctions with other ditches, and at other locations where erosion is likely to occur. On slopes over ten (10) percent, consideration should be given to the construction of larger sized channel linings, gabions (wire boxes) or paved channels with energy blocks or dissipators to reduce excessive velocities and damage to receiving streams.
- d. Consideration shall be given for the construction of other methods of lining for erosion control including check dams, drop structures, gabions, etc. subject to approval of the Planning commission's duly authorized representative.

7. LOT GRADING AND DRAINAGE

- a. Lot grading shall be accomplished as follows: Except for driveways in transition (higher or lower than the street - See Appendix "C") within the limits of the public right-of-way adjacent to street pavements, all final grading for grass strip, driveway and sidewalk, shall comply with minimum and maximum grades in accord with typical sections for streets as shown in Appendix "C". For lots that drain toward streets which include curb and gutter sections, the area in the right-of-way within four (4) feet back of the curb shall be graded so that water drains to the street at a minimum grade of 1 inch per foot (approximately 8 percent). In the area reserved for sidewalks and/or driveways (i.e., four (4) to eight (8) feet back of the curb in single or two-family areas or four (4) to nine (9) feet in multi-family or commercial areas), a minimum final grade of 1/4 inch per foot (approximately 2 percent) toward the street is required. For streets with or without curb and gutter or sidewalks which include side ditches, refer to typical section within Appendix "C". All grading behind the street shall be done in a fashion that does not allow ponding of water adjacent to the paved street. For lots that drain away from the street, the area in the right-of-way within four (4) feet back of the curb shall be graded so that water drains away

from the street at a minimum grade of 1/2 inch per foot (approximately 4 percent).

- b. Lot areas outside of the limits of the building structure shall be graded toward or away from a point four (4) feet back of the curb so that water drains away from the building at a minimum grade of 1/4 inch per foot (approximately 2 percent) toward the street or into swales or natural drainage areas.
 - (1.) Topsoil: If grading results in the stripping of topsoil, topsoil shall be uniformly spread over the lots as grading is finished.
 - (2.) Trees: As many trees as can be reasonably utilized in the final development plan shall be retained, and the grading adjusted to the existing grade of the trees where practicable.
- c. Swales carry surface runoff from roofs, yards, and other areas to the rear of lots or along common property lines to streets or other drainage areas to prevent ponding of water near building structures or other portions of the lot. Surface drainage swales shall have a minimum grade of two (2) percent and shall be constructed so that the surface water will drain onto a street, storm inlet, or natural drainage area. Swales for handling lot drainage shall be constructed as a part of final lot grading and be seeded and mulched or sodded as soon as possible to prevent erosion.
- d. Roof downspouts, footing, or foundation drains, and sump pumps shall be discharged onto the same parcel of land from which the water is generated. Roof downspouts shall be piped to natural drainage areas away from the street or onto concrete splash blocks, which direct water away from the building structure into swales or other natural drainage areas. Except as permitted by adopted policy within residential property regimes, downspouts or other subsurface drains constructed toward the street shall be discharged on the surface as far back onto the lot as possible and in no case be closer than 20 feet back from the nearest curb of the street. Roof and subsurface drains shall not be connected thru the curb or into the gutter section of the street. Any connection into a storm sewer or catch basin must be approved by the inspector.

F. DESIGN CRITERIA OF STORM WATER RUNOFF CONTROL FACILITIES

1. GENERAL CRITERIA

In order to minimize runoff damage to downstream properties, sediment pollution of public and private waters, and hydraulic overloading of existing drainage facilities, the peak storm water discharge from a land disturbing activity or development and redevelopment activities after development shall not exceed the peak pre-development discharge from that activity for the 2, 10,

25, and 50-year storm events. Storm water runoff control facilities are required for all land uses including single and multi-family residential, mobile home park, urban and rural commercial, shopping center, professional office, planned unit development, mixed land use, research park, institutional, industrial, and public facilities. Such facilities are also required for other activities that include impervious surfaces that generate increased runoff requiring storage in accord with these regulations. These facilities may be designed for each individual site, but the use of regional facilities is encouraged. These shall be designed so that no standing water will remain in detention facilities during dry weather, or that standing water in retention facilities will not be allowed to stagnate and present health hazards. The use of other methods of controlling peak discharge rates such as bioretention swales and structures and created wetlands are encouraged by the Planning Commission. The amount of water to be detained shall be determined by the methods described in the following paragraphs using the design criteria as referenced in Section C.

2. DESIGN METHODS

An accepted method that generates an inflow/outflow hydrograph such as the Soil Conservation Service (SCS) method or Modified Rational Method (MRM) as detailed in Section 300 shall be used. It is recommended that a computer program be used to develop these hydrographs. All documentation shall be submitted for review by the planning commission's duly authorized representative.

3. DISCHARGE HYDROGRAPHS

For project sites where the pre-development peak discharge has been calculated by the Rational Method, a discharge hydrograph must be calculated for the site using one of the methods allowed in Section 300. Unlike the Modified Rational Method (MRM), the SCS Method uses the Type II rainfall distribution based upon the 24-hour steady storm duration.

4. DESIGN STORMS

The pre-development site runoff shall be calculated for the 2, 10, 25, and 50-year storm frequency. The entire acreage contributing to the runoff shall be included in the calculations.

5. POST-DEVELOPMENT RUNOFF

The post-development site runoff shall be calculated for the ultimate development for the site based on the 2, 10, 25, 50 and 100-year frequency storm. The entire acreage contributing to the runoff shall be included in the calculations.

6. BASIN STORAGE VOLUME

The minimum basin storage volume shall be the difference between the post-development and pre-development 50-year storm inflow and outflow hydrographs, or the volume necessary to sufficiently reduce post-development discharges to a rate needed to meet the capacity of existing culverts and

drainage systems immediately downstream of the site proposed for development. If the basin is to be located directly on a portion of the through drainage system, volume calculations must also consider the total system flow reaching the basin. If the Modified Rational Method is used by computer program, the storm duration used shall be the one that produces the maximum storage, if calculating by hand the duration shall be greater than the time of concentration.

7. **OUTLET STRUCTURES**

The discharge from the detention/retention basin shall be controlled by a multi-stage release outlet structure and not be greater than a pre-developed runoff rate based on a 2, 10, 25, and 50-year storm frequency at that particular point where the discharge occurs. The emergency spillway shall be sized to accommodate a flow equal to the 100- year storm post-development discharge. The routing of an emergency spillway shall be shown based on the 100-year storm frequency. Trash racks shall be installed on the low flow outlet in detention basins. For basins installed on a FEMA-regulated drainage system as shown on FEMA Flood Insurance Rate Maps (FIRMs), water surface profile for maximum storage shall be in accordance with FEMA guidelines for the appropriate watershed.

8. **DESIGN STANDARDS**

These standards apply to permanent and temporary storm water runoff, sediment, and debris basins formed by an embankment, or excavation. These standards are limited to the installation of basins on sites where failure of the structure will not result in loss of life, damage to adjacent properties, or interruption of use or service of public utilities; the area draining to the structure does not exceed 200 acres; and the water surface at the crest of the emergency spillway does not exceed five (5) acres.

1. All basins that shall be designed and built with side-slopes no greater than 3:1 (three feet horizontal per one foot vertical), paved channel bottoms and proper outlet structures to insure no standing water during dry periods.
2. The dam crest elevation shall not be less than one (1) foot above the emergency spillway invert or overflow elevation.
3. Discharge velocities within pipe must be controlled to same requirements as specified in Section D. Erosion control linings for open channels must comply with requirements in Section E.
4. Storage, discharge, and routing calculations for the 2-year, 10-year, 25-year, 50-year and 100-year discharges must be submitted for review.
5. Spillways shall be protected from erosion and shall employ energy dissipation, if necessary.
6. Detention basins shall be fully discharged within 36 hours of the storm event.
7. Fencing may be required by the Planning Commission's duly authorized representative or local governments when the location of the detention area is not easily observed or the side slopes of the basin are steeper than 4:1 (four feet horizontal per one foot vertical).

8. If required, ponds shall have dams and spillways that conform to the current Design Criteria For Dams and Associated Structures, Kentucky Division of Water. In cases when the top of the dam is also a publicly dedicated street right-of-way, the developer shall have a geotechnical report prepared with recommendation on the design and construction of the dam.
 9. The designer shall include anti-seep collars, baffles, and outlet protection, when required.
 10. Maintenance accessibility and responsibility for maintenance shall be included.
9. **ROUTING OF STORM HYDROGRAPH THROUGH THE FACILITY**
 Hydrographs for the 2-year, 10-year, 25-year, 50-year and 100-year storm events shall be routed through the proposed storm water management facilities using the Modified Puls Method or another method approved by the Planning commission's duly authorized representative. A request for approval of an alternative method should be submitted to the Planning commission's duly authorized representative prior to running the model and shall be reviewed on a case-by-case basis.
10. **PARKING LOT STORAGE**
 Parking lot storage involves shallow ponding in a specifically graded area of a parking lot. The major disadvantage is the inconvenience to users during the ponding function. Clogging of the flow control device and icy conditions create maintenance and safety problems. This method is intended to control the runoff directly from the parking area and is not appropriate for storing large volumes. Parking lot storage shall generally be limited to those areas served by combined sewers; primarily in the extremely urbanized areas of the counties. Parking lot storage may be approved in separate sewer areas on a case-by-case basis.
 General design requirements include:
1. Maximum water depth - 8 inches.
 2. Minimum distance of ponding area from buildings - 10 feet.
 3. Maximum surface slope - 5.0%
 4. Minimum surface slope - 1.0%
 5. Maximum discharge to combined sewer system - 10-year pre-development discharge.
12. **MAINTENANCE RESPONSIBILITIES**
 Unless dedicated to and accepted by a legislative body, the owner of each lot and/or the developer of each subdivision shall be responsible for properly maintaining each storm water runoff control facility in order for such facility to function according to its design and purpose. Maintenance provisions for the facility shall be noted on the submittal plans, including access roads. If publicly dedicated, the facility shall be included within the right-of-way and shown on the Final Plat submitted to the appropriate city/county. In residential subdivisions, all facilities shall be deeded to the appropriate legislative body and the area shall be shown as a Lot on the Final Plat. For any retention basin, only the appropriate inlet structures and outlet

structures shall be dedicated to the appropriate legislative body. The area of the pond or lake shall be owned and maintained by the adjoining residents. This shall include maintaining the shoreline and removing sediment, and shall be included in the Subdivision's Restricted Covenants, if applicable. For storm water runoff control facilities that are accepted for maintenance by a city or county and require special maintenance activities, such as undisturbed natural buffer areas, specific maintenance procedures shall be included in the transfer agreement.

13. **WAIVERS FOR STORMWATER RUNOFF CONTROL FACILITIES**

Certain factors, variations, and/or options will be considered in granting waivers for on-site storage design as part of the review process at the Stage I/Preliminary Plat, Improvement Drawings and Specifications and/or Stage II/Site Plan stages. Waivers granted will be determined from the following:

- a. All agricultural uses unless otherwise required by other federal and/or state agencies regarding storm water regulations as "permitted".
- b. All single-family residential developments having a minimum lot size of at least one (1) acre or greater provided that the increase in runoff calculated using runoff curve numbers (RCN) or runoff coefficients (C) does not cause problems, deficiencies and damages in the length of channels or reaches downstream determined by a hydrograph based upon the time of concentration or duration of the design storm required. In any development where a storage design is required credits are prohibited. Post - Development runoff curve numbers (RCN) or runoff coefficients (C) may not be less than pre - development runoff curve numbers (RCN) or coefficients (C).
- c. Where increased runoff from a development flows into a pre-existing downstream storage facility and routing channels and storage capacity through such facilities are analyzed and improvements made, where necessary or required.
- d. Where mitigation of known on-site or off-site deficiencies are determined, engineered and resolved by the sub divider or developer in cooperation with all applicable jurisdictions impacted as assurance that increased runoff will be adequately handled or dissipated without cause for damage during the design storm required.
- e. Where a determination has been made that regional storage design beyond the site in question is necessary, equivalent cost of requirements for on-site detention/retention storage may be substituted for immediate construction in the form of a Regional Facility Fee as calculated based on a policy of the planning commission included within its By-Laws.
- f. Where off-site/downstream improvements are required to remedy culvert/channel deficiencies determined by runoff calculation methods

and/or a hydrograph, such improvements shall be submitted as part of Improvement Drawings and Specifications and approved for construction prior to approval of a Final Plat or Site Plan.

- g. Where detention/retention storage design is not appropriate due to result of hydrograph analyses, and peak discharge and runoff volumes do not pose a problem or result in damages within the length of open channel or closed conduit determined by the time of concentration or duration of the design storm required.
- h. Buildings and their related parking areas and other structures where less than two (2) acres of land is to be altered by grading, draining, removing existing ground cover or paving; and, of which 1/2 acre or less will be impervious acres such as roofs, walks, and parking areas. However, this waiver is based upon the stipulation that such impervious hard surfaces are an isolated part of drainage area and not a part of the same drainage or watershed area contributing to an accumulated and combined discharge exceeding the downstream discharge/runoff control requirements of these regulations.

SECTION 7.1 SANITARY SEWER SYSTEM: Except as herein provided, the subdivider shall construct a sanitary sewage collection system designed to serve adequately all lots in the subdivision plus lines adequate in size to facilitate the orderly development of nearby land which is an integral part of the neighborhood service or drainage area (see Section 7.7 of these regulations) and connect said collection system to a centralized sewerage system, or an approved package treatment plant (surface discharge).

- A. **PLANS REQUIRED:** The subdivider shall submit plans and specifications prepared by a registered professional engineer, showing the proposed sanitary sewerage system and facilities. Said plans shall show pipe sizes, gradients, type of pipe, invert elevations, location and type of manholes, the location, type and size of all lift or pumping stations, location, type and capacity of all proposed package treatment plants, and all construction details including such information as required by the planning commission's duly authorized representative.
- B. **DESIGN STANDARDS:** Where applicable, the design criteria for the sanitary sewerage system shall comply with the following published standards, regulations or laws, as applicable:
 - a. "Recommended Standards for Sewage Works" prepared by the Great Lakes-Upper Mississippi River Board of State Sanitary Engineers, Health Education Service, Inc, Albany, New York, 1978; and
 - b. State Water Laws and Regulations, and other state statutes, as applicable.
- C. **MATERIAL AND CONSTRUCTION SPECIFICATIONS:** Material and construction specifications, including testing requirements for all sanitary sewer projects shall be in accordance with the Rules and Regulations of the city of Falmouth or other applicable Sanitation District, except as herein provided.

D. INDIVIDUAL ON-SITE SEWAGE DISPOSAL SYSTEMS:

- 1) Where proposed development is presently not served by a public sanitary sewer system, and is not located within a reasonable distance of an existing or proposed sanitary sewer line as determined by the planning commission or its duly authorized representative, on-site sewage disposal systems may be permitted provided that such systems shall be designed and constructed in accordance with the regulations of the applicable state and local agencies.
- 2) In the event that existing or proposed sanitary sewer lines are located within a reasonable distance of the site, as determined by the Planning Commission or its duly authorized representative, then said site shall be connected to the public sanitary sewer system. Where permitted under these regulations, all such systems shall also be approved by the appropriate agencies.

SECTION 7.2 WATER SYSTEM: It shall be the responsibility of the subdivider to contact the applicable Water District or other applicable water service agency, indicating their proposed layout of the water distribution system, according to the subdivision procedures identified in Article III of these regulations. The subdivider shall design and construct a complete water distribution system which shall serve adequately all lots within the proposed subdivision plus coordinated with the applicable Water District, lines adequate in size to facilitate the orderly development of nearby land which is an integral part of the neighborhood service area. Where proposed development is presently not served by a public water system, and is not located within a reasonable distance of an existing or proposed public water system as determined by the Planning Commission or its duly authorized representative, a connection to a public water system is not required.

A. PLANS REQUIRED: The subdivider shall submit plans and specifications prepared by a registered professional engineer, showing the proposed water system. Said plans shall show line sizes, type of pipe, location of hydrants and valves and other appurtenances, if applicable, supply facilities, booster pumps, elevated or ground-level storage tanks, including all construction details.

B. DESIGN STANDARDS: The design criteria for the water distribution system shall be based upon regulations of the applicable water district, and the following requirements:

1. MINIMUM FIRE FLOWS

- (a) **MINIMUM FIRE FLOWS:** The Minimum Fire Flow in areas served by a public water system is 500 gpm (gallons per minute) at 20 psi (pounds per square inch) residual pressure unless otherwise approved in writing by the applicable Fire District's Fire Chief.

Minimum fire flow from a source shall be determined from an adequate fire flow test described below within Section 7.2 B, 2. Minimum fire flow will be utilized by the applicable water district and/or planning

commission as a requirement for approval of any proposed Preliminary Plat requiring a public water supply.

(b) **ADDITIONAL REQUIREMENTS:** The Insurance Services Office (ISO) Guideline Fire Suppression Rating Schedule for safety and consumer protection is recognized as a goal for levels of fire flow in residential subdivisions. Upon determination by the Planning Commission, that it is practicable for the purpose of increasing the fire flow above the minimum required within subparagraph (a) above, based upon economic feasibility in proportion to the development, any of the following can be required as a condition/requirement for approval of any proposed Preliminary Plat requiring a public water supply:

- (1) Upsizing or replacement of any existing off-site water system facility or infrastructure; and/or
- (2) Construction of circulation or interconnection with another water system; and/or
- (3) Providing other alternative water supply sources.

2. **FIRE FLOW TESTING:** Available fire flow in an area proposed for development shall be determined from an adequate fire flow test performed by the applicable water district, qualified consultant and/or fire department. Fire flow testing shall conform to standard procedures as recommended in the National Fire Protection Association (NFPA) Fire Protection Handbook including the following: (a) static and residual pressures in pounds per square inch using a hydrant cap or hose cap drilled for a pressure gauge; (b) internal diameter of flowing hydrant nozzle orifice in inches, discharge coefficient and recorded pressure using a pitot gauge; and (c) available fire flow in gallons per minute at a residual pressure of 20 pounds per square inch.

3. **WATER MAIN SIZES:** Upsizing of water distribution mains for primary transmission and/or secondary feeders shall be based upon the applicable water district's Master Plan, where applicable.

4. **FIRE HYDRANT LOCATION/SPACING:** Hydrants shall be spaced so as to be not more than 450 feet between hydrants in residential areas of one and two-family dwellings and not more than 300 feet between hydrants in areas of high volume or high density unless otherwise approved in writing by the applicable Fire District's Fire Chief.

The location/spacing of fire hydrants relate to lengths along streets, drives, yards, etc., as fire hose is placed. All deadended systems are subject to approval by the applicable water district.

C. **MATERIAL AND CONSTRUCTION REQUIREMENTS:** Material and construction specifications, including testing requirements for all water distribution systems, shall

be in accord with the rules and regulations of the applicable water district, where applicable.

SECTION 7.3 STREETS:

- A. **PLANS REQUIRED:** The subdivider shall submit plans and specifications prepared by a registered engineer showing the proposed street system. Said plans shall show the proposed right-of-way width, pavement width, location and the proposed alignment, grade, geometric details and typical cross-sections of each proposed street, including curbs and gutters and sidewalks (where applicable). Said plans and specifications shall show for each proposed street, design criteria such as street classification, pavement classification and thickness and classification and thickness of base and subbase materials.

In addition, the following information shall be required:

1. The plans and profiles of all surrounding streets which are to connect to a street in the proposed subdivision (for a distance of one hundred (100) feet back from the boundary line of the proposed subdivision).
 2. All profiles shall be drawn at a scale not to exceed one inch = 50 feet (horizontal) and one inch = 10 feet (vertical).
 3. Existing and proposed grade elevations shall be shown at all regular station points including vertical sag P.I.(s), P.C.(s) and P.T.(s) and percent grade between P.I.
 4. Elevations shall be tied to a bench mark (U.S.G.S. or other bench-marks when available), when, within a reasonable distance (as determined by the planning commission's duly authorized representative) and shall be shown on the Improvement Drawings and Specifications.
 5. Details of curb and gutter, sidewalks, street section and paving shall be shown.
- B. **PAVEMENT SPECIFICATIONS:** All streets shall be paved with Portland Cement concrete or asphalt concrete and constructed in accordance with the specifications in Appendix "A" or "B" (whichever is applicable) of these regulations.
- C. **MINIMUM PAVEMENT WIDTHS:** Pavement widths shall be measured from back of curb to back of curb, or if no curbs are required, then measurements shall include the entire paved surface. Minimum pavement widths for each street shall be as shown in Table 3 and laid out in the manner indicated by the typical street cross sections shown in Appendix "C".
- D. **CURBS AND GUTTERS:** The subdivider shall construct vertical curbs, for all residential streets (where applicable) as identified in Table 3. For streets to be

constructed of asphalt concrete, curb and gutter shall be constructed according to the typical section detail in Appendix "C".

All curbs and gutters shall be constructed of Portland Cement concrete and in accordance with the specifications in Appendix "A" and typical cross-sections in Appendix "C".

- E. CURB RADII: The minimum curb radius at intersections shall be as follows:

TYPE OF STREET* INTERSECTION	MINIMUM CURB RADIUS (IN FEET)
Local - Local or Subcollector	25
Subcollector - Subcollector	25
Subcollector - Collector	30
Collector - Collector	30
Arterial - Arterial	**

* In the case of local or collector streets located in commercial or industrial areas, the minimum curb radii shall be increased to fifty (50) feet.

** Shall be based on current design standards of the Kentucky Department of Transportation.

- F. SIDEWALKS: Sidewalks shall be required as identified in Table 3 of these regulations. The planning commission may grant a modification or waiver to the sidewalk regulation, providing the planning commission shall find: a) that the proposed development contains a minimum density of one (1) dwelling unit per two (2) net acres and / or lots with 200 foot frontage widths; and b) that the development or request will generate low traffic volumes without adversely jeopardizing pedestrian safety; and c) that the provision for sidewalks abutting existing streets or roadways or other roadways is impracticable, unnecessary or will contribute to an attractive nuisance or other safety hazard further regulated by Section 8.5 of these regulations.

Alternative pedestrian walkways to those identified in Table 3 of these regulations may be permitted by the planning commission provided such alternative(s) are determined to constitute an integral pedestrian circulation system equal to, or exceeding the requirement for sidewalks along both sides of a street. Such alternative pedestrian walkways may be within the public right-of-way, outside the public right-of-way within a public pedestrian circulation easement, or combination thereof. Pedestrian walkways within the public right-of-way shall be constructed of Portland Cement Concrete in accordance with the specifications of Appendix "A" of these regulations, at least four (4) inches thick and increased to five (5) inches of thickness when included as part of a driveway. Pedestrian walkways along the street shall be laid out in the manner indicated by the typical cross-sections shown in Appendix "C". Pedestrian walkways outside the public right-of-way determined to be a part of the integral pedestrian circulation system are permitted to be Asphaltic Concrete provided they are in accord with Appendix "B", or approved

equal, a minimum of five (5) inches thick and proof-rolled prior to placement of the Asphaltic Concrete. All pedestrian walkways determined to be a part of the integral pedestrian circulation system shall be constructed with a minimum width of four (4) feet in single-family residential areas, and five (5) feet in multi-family residential and commercial areas, where pedestrian traffic volume indicates the need for this additional width. Pedestrian walkways outside the public right-of-way determined not to be a part of the integral pedestrian circulation system are not regulated herein, however such pedestrian walkways may be regulated by other applicable agencies or law(s) (i.e. Americans with Disabilities Act).

1. Handicap Accessible Curb Ramps

Where sidewalks along streets are required, curb ramps or other hard surfaced pavements shall be installed at all new street intersections in accord with the U.S. Department of Justice's regulation of the Americans with Disabilities Act of 1990. Sidewalk Ramp types shall comply with Details indicated within Appendix C, where applicable. All ramps shall be designed (which may include additional inlets) to prohibit excessive stormwater from flowing onto ramps causing further safety and maintenance problems for use of such facilities.

- G. **PARKING:** Parking on any street where pavement width is less than thirty-six (36) feet shall be limited to one side of the street, except as otherwise noted within Table 3. Parking lanes shall not be shifted from one side to the other from block to block or where the proposed street is the extension of an existing street the parking lane shall extend continuously on the same side of the street. If practicable, the parking lane shall be located on the opposite side of the street from where the fire hydrants are located.
- H. **CUL-DE-SAC AND DEAD-END STREET:** Cul-de-sac courts and dead-end streets shall be designed in accordance with the typical design details as per Appendix "C" of these regulations. However, if conditions warrant, other turnaround designs may be permitted by the planning commission or its duly authorized representative. If such street is of a temporary nature and a further extension into adjacent land is anticipated, then said turnaround, beyond normal street width, shall be in the nature of an easement of the premises included in said turnaround, as per the typical design in Appendix "C". Such easement may be vacated to abutting property owners when said deadend street is legally extended into adjacent land. If such deadend street serves four (4) lots or less, no temporary turnaround will be required.
- I. **CONSTRUCTION OF REQUIRED PAVEMENT WIDTH ON EXISTING STREETS:** When a subdivision is located on only one side of an existing street, and where the pavement width of such existing street is less than that required by these regulations, the subdivider may be required to construct one-half (1/2) the required pavement width, as per these regulations, along the side fronting his property on such street.

J. INTERCONNECTION/EXTENSION

1. The arrangements of streets in new subdivisions with an existing street or streets or adjacent undeveloped land shall make provision for projection of streets to those adjoining areas in a timely fashion as required with approval of a Preliminary Plat, per Section 3.3 of these regulations.
2. Improvement Drawings and Specifications for interconnection with an existing street or extension to adjoining land shall be submitted for approval and construction when either one of the following conditions exist:
 - a. At least twenty-five percent (25%) of the lots or units approved as a Preliminary Plat or ten (10) lots or units, whichever is less, remain unplatted without construction of improvements and a secondary interconnection or extension to adjoining land; or
 - b. The terminus or stub of a street constructed in a new subdivision is 300 feet or less from such interconnection or projected terminus at the adjoining land.

Determination of compliance shall be made by the planning commission's duly authorized representative prior to approval of any new phase of Improvement Drawings and Specifications or individual Section of a Final Plat within the subdivision.

3. Final Plat for interconnection or extension shall include street right-of-way dedication to public use abutting existing street right-of-way or adjacent undeveloped land. Remnants of land, devil or spite strips are prohibited.
4. A guarantee may be filed with the planning commission's duly authorized representative in lieu of actual installation or completion of the required public improvements per Section 7.12 of these regulations.

SECTION 7.4 DRIVEWAY APPROACHES: Driveways for residential areas shall be provided with a minimum width as follows: one (1) lot or residence - nine (9) feet, or twelve (12) feet where the length of a driveway is 150 feet or more; two (2) lots or residences - twelve (12) feet; three (3) or four (4) lots or residences - sixteen (16) feet; each increasing in width by four (4) feet at the curb (i.e., two (2) foot flare or taper on each side of driveway) for court, cul-de-sac, local, sub collector and collector streets. In areas of heavier traffic volumes or where special conditions are encountered (Multi-Family, Industrial, Commercial areas), increased driveway widths, plus increased minimum radii or flares may be required by the planning commission, or its duly authorized representative. Except for driveways in transition from upward to downward slopes, all driveways within the right-of-way shall be constructed in accordance with standard construction details within Appendix "C" and the specifications of Appendix "A" or "B" (whichever is applicable) of these regulations. As an alternative to Section 7.3 F, driveways, aprons and sidewalks within driveway aprons may be constructed of other building materials including colored concrete stampings, solid brick, pre-manufactured pavers or other similar hardened materials, provided such construction complies with the minimum standard specifications

for sub-grade, strength and impermeability. Within the street right-of-way area, grades for upward sloping driveways within four (4) feet of the curb shall not be less than 1 inch per foot (approximately 8 percent) nor more than 2 inches per foot (approximately 16 percent). Grades for downward sloping driveways within four (4) feet of the curb shall not be less than 1/2 inch per foot (approximately 4 percent) nor more than 2 inches per foot. Sidewalks included as part of driveways or separate there from shall not be less than 1/4 inch per foot (approximately 2 percent) nor more than 1/2 inch per foot. Grades for upward or downward sloping driveways between edge of sidewalk and right-of-way line shall not be less than 1/4 inch per foot nor more than 2 inches per foot.

SECTION 7.5 STREET SIGNS:

- A. **STREET NAME SIGNS:** The developer, in conformance with standards established by the applicable legislative body or fiscal court shall be responsible for the installation of Street Name Signs prior to approval of a Final Plat. Street Name Signs shall conform to minimum standards contained within the "Manual on Uniform Traffic Control Devices", latest addition. In general, Street Name Signs shall be constructed on a single post located along the right side of the roadway at all intersections approximately two (2) feet from the pavement or curb at a height of seven (7) feet. Lettering on Street Name Signs should be at least 4 inches high. Suffixes may be in smaller lettering at least 2-inches high. A temporary sign is permissible until the permanent sign is erected.
- B. **TRAFFIC CONTROL SIGNS AND DEVICES:** The applicable legislative body or fiscal court shall arrange for the installation of traffic control signs and devices which shall be in conformance with the "Manual on Uniform Traffic Control Devices" as prepared by the Joint Committee on Traffic Control Devices, U.S. Department of Commerce, Bureau of Public Roads, as amended.

SECTION 7.6 MONUMENTATION:

- A. All corners of the boundary survey shall be monumented or witness monumented. Every monument set shall be of a type or character having a degree of permanency consistent with that of the local terrain and physical features. Wherever possible, monuments shall be made of a permanent material that makes it possible for the monument to be detected by a device capable of finding ferrous or magnetic objects. Types of acceptable monuments include, but are not limited to, iron pipes, iron pins, iron rods, re-bars, chiseled crosses, railroad spikes, mine spikes, P.K. nails and drill holes. Wooden stakes shall not be use as monuments. Each iron pipe, iron rod, iron pin or re-bar monument set by a land surveyor shall bear his registration number on a manufactured cap or identifier.
 - 1. Existing permanent manmade or natural features are acceptable monuments. Where manmade or natural features are subject to change, realignment or misinterpretation, such monuments or features shall be "witness monumented."

2. "Witness monumentation" shall be used when it is not possible or practicable to set the actual corner. Whenever witness monumentation is used, it shall be placed "on line" if possible and shall be shown on plats and called for in descriptions.

B. OTHER MONUMENTS: Other monuments set shall be metal pins of no less than one-half (1/2) inch diameter and no less than twenty-four (24) inches in length. Monuments of this type shall be set at all of the following locations:

1. At every point of intersection of the outer boundary of the subdivision with an existing or created right-of-way line of any street, railroad, or other way.

Appropriately identified markings shall also be located at each point along the street curb which intersects with the side lot lines of each lot.

SECTION 7.7 PLANS FOR FUTURE EXPANSION - EXTRA SIZE AND OFF-SITE IMPROVEMENTS: All improvements shall be installed to satisfy the service requirements for the service or drainage area in which the subdivision is located and the improvements shall be of sufficient capacity to handle the expected development of the overall service or drainage area involved.

EXTRA-SIZE IMPROVEMENTS: Where the planning commission's duly authorized representative has determined that improvements in excess of the size needed to serve the proposed subdivision are required, and are determined by the planning commission to be economically feasible in proportion to the development, the planning commission can require additional improvements above the minimum standards set forth herein.

SECTION 7.8 PLANS REQUIRED FOR GRADING AND CONTROL OF EROSION AND SEDIMENTATION: Any developer who intends to make changes in the contour of any land proposed to be subdivided, developed, or changed in use by grading, excavating, or removing the natural topsoil, trees, or other vegetative covering thereon, shall submit a plan for grading and erosion and sedimentation control to the planning commission's duly authorized representative for approval.

Such plans, if required, shall contain adequate grading measures including the control of erosion and siltation where necessary, using current acceptable guidelines and requirements contained herein.

A. REQUIREMENTS:

1. One (1) set of plans for grading and the control of erosion and sedimentation shall be submitted to the planning commission's duly authorized representative, as per the procedures established in Article III.
2. In the event the planning commission's duly authorized representative recommends final plat approval before construction of improvements, as per Section 3.9, A., 2., measures to be taken to control erosion and

sedimentation shall be included, in the plans above as provided as per these regulations.

3. During the construction phase, further technical assistance may be furnished, if requested, by the planning commission's duly authorized representative, or by the local representative of the Natural Resources Conservation Service. However, the planning commission, or its duly authorized representative, shall enforce compliance with the approved plans.
4. The planning commission's duly authorized representative shall make periodic inspections of the methods used and the overall effectiveness of the erosion and sedimentation control program.

B. EARTHWORK GRADING AND EROSION CONTROL MEASURES: The following control measures should be used for an effective erosion and sedimentation control plan for the area under development:

1. The smallest practical area of land should be exposed at any one time during development.
2. When land is exposed during development, the exposure should be kept to the shortest practical period of time.
3. Where necessary, after grading, temporary vegetation and/or mulching should be used to protect areas exposed during development.
4. Sediment basins (debris basins, de-silting basins, or silt traps) should be installed and maintained until ground cover has been completed to remove sediment from runoff waters from land undergoing development.
5. On-site provisions should be made to effectively accommodate the increased runoff caused by changed soil and surface conditions during and after development.
6. The permanent final vegetation and structures should be installed as soon as practical in the development.
7. The development plan should be fitted to the topography and soils so as to create the least erosion potential.
8. Wherever feasible, natural vegetation should be retained and protected.

SECTION 7.9 CONSTRUCTION INSPECTIONS:

A. AUTHORITY AND DUTIES OF INSPECTORS: Inspectors are authorized to inspect all work done and all materials furnished. Each inspector shall have one (1) complete set of all plans and specifications with certified approval by the planning commission's duly authorized representative. Such inspection, including final

inspection, may extend to all or any part of the work and to the preparation, fabrication, or manufacture of the materials to be used. Except for minor deviations, the inspector shall not be authorized to revoke, alter, or waive any requirements of the approved plans related to grading, public improvement construction, erosion control plans, and Improvement Drawings and Specifications. Contractors shall notify the inspectors at least 12 hours prior to the time when the work is to begin on each phase of construction, including erosion control, earthwork related to public improvements, storm sewer systems, sanitary sewer systems, street paving and driveway/sidewalks including all related testing, etc., where applicable.

The inspector shall commence inspections at the time of work starts and continue inspections necessary and appropriate in the circumstance as the work progresses on each phase of the project until all construction is complete. Any work determined by the inspector not to conform to the requirements of the approved Grading Plans including erosion control, and Improvement Drawings and Specifications or other requirements of these regulations shall be suspended and such construction brought into conformance with plans and standards as approved.

When minor deviations regarding design or construction specifications are observed during on-site inspections, the planning commission's duly authorized representative, has been delegated certain discretionary judgment. Prior to permitting a minor deviation, the planning commission's duly authorized representative's judgment shall include findings that such deviation(s) will not be: a) in conflict with the intent and purpose of these regulations; b) in dispute with a majority of generally accepted AASHTO or ASTM industry standards or other standards regarding engineering judgment as determined by the planning commission's duly authorized representative, where applicable; and c) detrimental to the public interest. Where such deviations are permitted, the planning commission's duly authorized representative may require a guarantee or warranty for the construction at issue for a time period not to exceed twelve (12) months.

The planning commission's duly authorized representative reserves the right to order items removed and replaced and/or additional testing when work was performed contrary to approved plans and specifications, or without adequate notification for inspection. Following final inspections of improvements, the planning commission's duly authorized representative shall certify, in writing, to the applicable cities and/or fiscal court, that improvements have been constructed in accord with grading plans including, erosion control plans, and Improvement Drawings and Specifications and inspected per these regulations, if such is the case.

SECTION 7.10 CONSTRUCTION RESPONSIBILITIES:

- A. **COOPERATION OF SUBDIVIDER AND/OR CONTRACTOR:** The subdivider and/or contractor(s) shall have available on the project, one (1) complete set of all plans and specifications, as approved by the planning commission's duly authorized representative and other local and state government agencies, where "permitted". Contractors shall cooperate with the inspector and with other contractors in every way possible. The subdivider and/or contractor shall, at all times, during actual

construction, have a competent superintendent acting as his agent on the project. The superintendent shall be capable of reading and thoroughly understanding the plans and specifications and he shall receive instructions from the inspector. The superintendent shall have full authority to execute the orders or directions of the inspector. A superintendent shall be furnished irrespective of the amount of work sublet. Subdividers and contractors are not relieved of other responsibilities and requirements of other state and local agencies relating to zoning, permits, etc., which may be beyond the scope of requirements of the Subdivision Regulations. Satisfactory completion of inspections and certification that improvements have been constructed in accord with grading plans, erosion control plans, and improvement drawings and specifications per these regulations, shall not be a defense in an action for damages against anyone who may be liable by reason of non-compliance with the requirements of these regulations.

SECTION 7.11 FINAL CLEANING UP: Upon completion of the work, the subdivider and/or contractor shall clean up all ground occupied or affected by him in connection with the work.

SECTION 7.12 AGREEMENTS AND GUARANTEES:

- A. **GUARANTEES:** The subdivider may execute and file guarantees with the planning commission's duly authorized representative, in lieu of actual installation or completion of the required improvements, except sidewalks, when requesting approval of the final plat. In the case where sidewalk improvements have not been completed (i.e., construction of sidewalks as regulated herein are the responsibility of the builder and owner of the lot in question and are not required to be completed or guaranteed prior to final plat approval), a conditional certificate of occupancy may be given by contract with the applicable legislative body or fiscal court not to exceed six (6) months signed by both the builder and owner of the premises for which the improvements will serve.

Guarantees, shall be based on a cost estimate for the required improvements, for each phase of uncompleted construction as estimated by the subdivider's engineer. Such guarantees shall run to the planning commission and be acceptable by the planning commission's duly authorized representative and the commission's legal counsel. The cost estimate shall be based on the amount determined to be reasonably necessary to complete all of the improvements required to be constructed by the subdivider, as specified in the approved improvement drawings and specifications, including a ten (10) percent contingency plus engineering fees and the fees for plan review and construction review as established by the By-Laws.

Except as herein provided, the guarantee shall be in the form of a good and sufficient surety bond, executed by the subdivider as principal, and a corporation authorized to act as a surety under the laws of the state of Kentucky, as surety. The guarantee shall be an assurance of faithful performance of any and all work and the construction and installation of all improvements required to be done by the subdivider, as specified in the approved improvement drawings and specifications,

together with contingency plus all engineering fees and the fees for plan review and construction review as established by the By-Laws.

Except as required within Section 7.3, J. regarding street interconnection/ extension, the guarantee shall contain the further condition that, should the subdivider fail to complete all work and improvements required to be done by him within twenty-four (24) calendar months of the date of approval of the final plat, or within a mutually agreed upon extension, but never to exceed twelve (12) consecutive calendar months, that the planning commission or its duly authorized representative shall cause all required work to be done and improvements constructed. The parties executing the guarantee shall be firmly bound for the payment of all necessary costs therefore. Whenever the subdivider elects to execute alternative forms of guarantee (i.e., cash, bonds, letter of credit, escrow agreement, etc.), such instruments including the engineer's itemized cost estimate plus contingency, type of surety and amount shall be filed and reviewed by the planning commission's duly authorized representative including the commission's legal counsel prior to approval of such guarantee and a final plat. All guarantees shall include a provision that, in the event of any default on the part of the subdivider or the performance of any work or construction of any improvements for which such guarantees have been deposited, to cause the required work to be done and to withdraw that amount required for payment of all costs therefore.

Following final inspections of improvements guaranteed, the planning commission's duly authorized representative shall so certify in writing to the surety or other guarantee holder regarding such completion to permit the release or return of the guarantee to the subdivider within ten (10) days of such final inspection certification.

**TABLE 3
IMPROVEMENT REQUIREMENTS BY TYPE OF STREET**

TYPE OF STREET	NUMBER OF LOTS SERVED	RIGHT-OF-WAY (ft)	PAVEMENT WIDTH (ft)	CURB AND GUTTER	SIDEWALKS ALONG STREET	ON STREET PARKING	MINIMUM FRONT YARD DEPTH (ft)	OFF-STREET PARKING REQUIRED	MINIMUM LOT WIDTH AT SETBACK (ft)	MINIMUM PAVEMENT THINCKNESS
COURTS										
Deadend										
Typical	Under	40	22	Yes	None	One Side				(C)
Optional	7	50	20	No (A)	None	None	50	4 spaces (B)	100	(C)
CUL-DE-SAC										
Deadend										
Typical	7-25	50	25	Yes	One Side	One Side				(C)
Optional	7-25	50	20	No (A)	One Side	None	50	4 spaces (B)	100	(C)
LOCAL										
Typical	Under	50	25	Yes	Both Sides	One Side				(C)
Optional	100	50	20	No (A)	Both Sides	None	50	4 spaces (B)	100	(C)
SUB-COLLECTOR										
Typical	100-	50	28	Yes	Both Sides	One Side				(C)
Optional	500	50	22	No (A)	Both Sides	None	50	4 spaces (B)	100	(C)
COLLECTOR										
Typical	Over	60	30	Yes	Both Sides	One Side				(C)
Optional	500	60	22	Yes	Both Sides	None	50	4 spaces (B)	100	(C)

Note: Where streets are to serve industrial or commercial areas, the pavement design shall be based on a study prepared by the subdivider's engineer, projecting the type of vehicles using the street, traffic volumes, and recommended pavement design. Such design shall be approved by the planning commission's duly authorized representative.

- (A) Shoulders and side ditches may be permitted and designed in accordance with these regulations provided the minimum front depth is 50 feet, and the minimum lot width is 100 feet.
- (B) Individual off-street parking spaces shall be laid out in such a manner to insure that each space has unrestricted ingress and egress to a public street (i.e., not blocked from gaining access to the street via another parked vehicle).
- (C) Minimum pavement thickness for Portland cement concrete and asphalt concrete shall be designed in accordance with Appendices A and B , respectively.

Note: Arterial streets shall be designed in accordance with the requirements of the Kentucky Department of Transportation.

**ARTICLE VIII
ADMINISTRATION AND ENFORCEMENT**

SECTION 8.0 ADMINISTRATION: It shall be the responsibility of the planning commission's duly authorized representative to administer these regulations, including performance of all inspections in behalf of the commission, except where specific authority is retained by the planning commission, as provided per these regulations.

SECTION 8.1 FEES FOR PRELIMINARY AND FINAL PLATS; GRADING PLANS; IMPROVEMENT DRAWINGS AND SPECIFICATIONS; INSPECTIONS AND OTHER PLATS: The schedule of fees, charges, etc. shall be as established by the planning commission's By-Laws.

SECTION 8.2 PAYMENT OF FEES: The subdivider shall pay all fees to the planning commission's duly authorized representative at the time of submitting plats, improvement drawings and specifications, and grading plans for approval. Said fees shall be paid by cash, check or money order only, and made payable to the Pendleton County Joint Planning Commission.

SECTION 8.3 FEES FOR INSPECTING IMPROVEMENTS AS PER APPROVED GRADING PLANS, IMPROVEMENT DRAWINGS AND SPECIFICATIONS, AND/OR FINAL PLATS: An inspection fee shall be charged to the subdivider for inspections during the construction of the improvements. Said inspection fee shall be based on a unit cost per lineal foot of each item of construction required to be inspected (e.g. storm sewer systems, street paving including earthwork related to public improvements construction, erosion control, driveways and/or sidewalks, etc) measured from grading plans, improvement drawings and specifications and/or final plats by the planning commission's duly authorized representative. Inspection fees shall be paid by cash, check or money order only, and made payable to the Pendleton County Joint Planning Commission. During construction inspections, the planning commission's duly authorized representative will use collected inspection fees to cover costs for construction inspections.

SECTION 8.4 FEES FOR RECORDING FINAL PLATS IN COUNTY CLERK'S OFFICE: The subdivider shall pay the recording fee as per the requirements of the County Clerk's office.

SECTION 8.5 MODIFICATIONS: The planning commission may grant a modification or waiver to these regulations, as specified herein, providing the planning commission shall find:

- A. That unusual topographical or exceptional physical conditions exist; or
- B. That strict compliance with these regulations would create an extraordinary hardship in the face of the exceptional conditions; or
- C. That the modifications would provide for innovative design layout of the subdivision; or
- D. That strict compliance with any section of these regulations could cause an unsafe situation.

In granting any modification or waiver to these regulations, the planning commission shall find that said modification or waiver will not be detrimental to the public interest nor in conflict with the intent and purpose of these regulations. In addition, when granting a modification or waiver to these regulations the planning commission may impose conditions on the subdivider as determined necessary to accomplish the intent and purpose of these regulations.

SECTION 8.6 ENFORCEMENT:

- A. **REVISION OF PLAT AFTER APPROVAL:** No changes, erasures, modifications, or revisions shall be made in any plat of a subdivision after final approval has been given by the planning commission's duly authorized representative and an endorsement is made in writing on the plat, unless the plat is first resubmitted and the changes approved by the planning commission's duly authorized representative.
- B. **ENFORCEMENT BY PLANNING COMMISSION OR ITS DULY AUTHORIZED REPRESENTATIVE:** The planning commission or its duly authorized representative, shall have a cause of action for all appropriate relief including injunctions against any governmental bodies or any person who violates any of these regulations.

SECTION 8.7 PENALTIES: Pursuant to KRS 100.991, any person or entity who violates any of these regulations shall, upon conviction, be fined not less than ten dollars (\$10.00) but not more than five hundred dollars (\$500.00) each day of violation shall constitute a separate offense.

SECTION 8.8 SEVERABILITY: If any article, section, subsection, sentence, clause, or phrase of these regulations is, for any reason, held unconstitutional or invalid, such decision or holding shall not affect the validity of the remaining portions thereof, it being the intent to enact each section and portion thereof, individually, and each such section shall stand alone, if necessary, be in force notwithstanding the validity of any other article, section, subsection, sentence, clause or phrase of these regulations.

SECTION 8.9 CONFLICT: All regulations, resolutions, orders, ordinances, and/or codes in conflict herewith are hereby repealed on the effective date of these regulations; providing, however, that such repeal shall not affect or prevent the prosecution or punishment of any person for any action done or committed in violation of any such Subdivision Regulations, Order, Resolutions, and/or Amendments thereto, hereby repealed prior to the effective date of these regulations.

ARTICLE IX

ADOPTION, AMENDMENT AND EFFECTIVE DATE

SECTION 9.0 PUBLIC HEARING: Before adoption of these subdivision regulations or any amendments thereto by the planning commission, a public hearing shall be held by the planning commission. A public notice of the time and place of the public hearing shall be published in a newspaper of general circulation in Pendleton County, in accordance with Kentucky Revised Statutes Chapter 424.

SECTION 9.1 EFFECTIVE DATE: These subdivision regulations shall take effect and be in force upon their adoption as provided for in KRS Chapter 100.

ADOPTED BY THE PENDLETON COUNTY PLANNING
COMMISSION, STATE OF KENTUCKY

DATE: _____

CHAIRMAN: _____

AMENDMENTS

NUMBER

SECTION

DATE ADOPTED

APPENDIX "A"

CEMENT CONCRETE FOR STREET, CURB AND GUTTER, SIDEWALK AND DRIVEWAY CONSTRUCTION.

The work covered by these specifications consists of furnishing all labor, equipment, and materials, and performing all operations in connection with the construction of air-entrained Portland Cement concrete pavement in accord with these specifications and the applicable Improvement Drawings.

The cement concrete pavement work shall consist of a single course of cement concrete, including reinforcement and longitudinal and transverse joints, where required, constructed on a prepared subgrade in general conformity with the lines, grades and cross-sections shown on the plans.

ITEM 1.0 GRADING

This term shall consist of all grading above or below subgrade elevations of whatever nature required to bring the street to proper subgrade elevations, including necessary excavation for curb, gutter, sidewalk, construction of embankments, excavation and proper sloping of all cuts, and other work incidental thereto.

- 1.1 EXCAVATIONS: All excavations shall be made to approximate grade or subgrade elevations consistent with approved plans. Except for utility trenches, excavations shall not be steeper than a cut slope of 2.5 horizontal to 1 vertical unless otherwise approved by a qualified/recognized geotechnical engineer.
- 1.2 EXCAVATION BELOW SUBGRADE: Whenever excavations below subgrade elevation to remove spongy or unstable material, organic matter, or other materials is required, the contractor shall remove same and shall replace with compactable soils as per Item 1.3. The excavation can be backfilled with soils that were removed, provided they are clean clayey soils free of organic matter and other deleterious material, aerated and dried to near optimum moisture content, or clean clayey borrow soils that have moisture contents near optimum moisture content.
- 1.3 CONSTRUCTION OF EMBANKMENT: All surface vegetation and heavy root system shall be removed to eliminate all vegetation from the area upon which the embankment is to be constructed. Soils so removed shall not be used in construction of embankment. These materials shall be stockpiled and respread across scarified areas after the scarified areas have been brought to within inches of finished grade.

Embankments comprised of clayey soils including clayey granular soils that exhibit well defined moisture density curves shall be constructed of approved soils to approximate subgrade elevation in shallow level layers, 6 to 8 inches, within two (2) percent of optimum moisture content on the dry side of the curve or within three (3) percent of optimum moisture content on the wet side of the curve, compacted with an appropriate type of compaction equipment to a density not less than 95 percent of maximum density,

as determined by the standard Proctor moisture-density test (ASTM D698-91 or AASHTO T-99) or 87 percent of maximum density as determined by the modified Proctor moisture-density test (ASTM D1557-91 or AASHTO T-180). Clean granular soils that do not exhibit a well defined moisture density curve shall be compacted to at least 75 percent relative density (ASTM D4253-95 and ASTM D4254-91) Except as otherwise approved by a Qualified/Recognized Geotechnical Engineer, all soils placed in areas directly impacting public improvements shall be constructed to slopes no steeper than 2.5 (horizontal) to 1 (vertical) and flatter where possible for ease of maintenance.

- 1.4 BACKFILL: Clayey soils or granular soils shall be used to backfill utility trenches within the limits of the right of way. Under no conditions shall any backfill be flushed with water to obtain compaction.

Clayey backfill soils for trenches within the limits of the public right of way shall be placed in the shallow level layers, six (6) to eight (8) inches in thickness, and each lift shall be thoroughly and uniformly compacted with kneading-type compaction equipment such as a sheepsfoot roller or self-propelled compactor. Clayey backfill soils beneath pavements and within three (3) feet of the back of curb along either side of pavements shall be moisture-conditioned to within two (2) percent of the optimum moisture content on the dry side of the curve or three (3) percent of the optimum moisture content on the wet side of the curve, and shall be compacted to densities not less than 95 percent of the standard Proctor maximum dry density (ASTM D698-91), or 87 percent of the modified proctor maximum dry density (ASTM D1557-91). Clayey backfill soils within the limits of the right of way greater than three (3) feet beyond the back of curb along either side of pavements shall be moisture conditioned to within three (3) percent of the optimum moisture content on the dry side of the curve or seven (7) percent of the optimum moisture content on the wet side of the curve, and shall be compacted to densities not less than 90 percent of the standard Proctor maximum dry density (ASTM D698-91) or 82 percent of the modified Proctor maximum dry density (ASTM D1557-91).

Granular backfill soils for trenches within the public right of way shall be placed in shallow level layers, six (6) to eight (8) inches in thickness, and each lift shall be thoroughly and uniformly compacted with an appropriate type of compaction equipment. Granular backfill which exhibits a well defined moisture density curve shall be moisture conditioned to within two (2) percent of the optimum moisture content on the dry side of the curve or three (3) percent of the optimum moisture content on the wet side of the curve and shall be compacted to 95 percent of the standard Proctor maximum dry density (ASTM D698-91) or 87 percent of the modified Proctor maximum dry density (ASTM D1557-91). Clean granular soils that do not exhibit a well-defined moisture density curve shall be compacted to at least 75 percent relative density (ASTM D4253-95 and ASTM D4254-91).

Controlled Low Strength Material (CLSM) also referred to as flowable fill, flowable mortar or lean mix backfill may be used in place of compacted clayey soils or granular soils to uniformly backfill sewer conduit or utility trenches, catch basins, manholes or other excavations. Material mixture shall conform to the following requirements unless approved as equal.

- (1) Materials and proportions - a) Cement - Type I and II; 0-50 not to exceed 75 pounds per cubic yard (lb/cu.yd.); b) Fly Ash - ASTM C-618 Class "C" or "F"; 250 - 400 lb/cu.yd.; c) Concrete Sand; 2600 - 2900 lb/cu.yd.; and d) Water; 400-500 lb/cu.yd. Contractor shall be responsible for determining if proposed mixture is proprietary and indemnify the planning commission or any legislative body from any claims.
- (2) Mixing - Backfill should be transported by mixing truck to ensure proper suspension when placed. Constant agitation is required.
- (3) Construction - Flowable fill is a fluid material. Caution should be used when backfilling pipe that is subject to flotation. Anchoring pipe by placing backfill in 8 to 12-inch lifts until fluid head resides may be necessary. When used to backfill aluminum pipe, adequate separation such as a bituminous coating shall be required. Fill material shall extend from the top of compacted bedding or other backfill to bottom of pavement structure.
- (4) Settlement and hardening - To expedite settlement and hardening, bleed water shall appear on the surface within 5 to 10 minutes after placement. CLSM is not concrete and should not be rated on setting time. The material will achieve density as soon as water leaves the mixture. The time involved until the fill may be paved over varies with permeability of adjacent soils, temperature, humidity, and moisture in these soils. In most conditions, the in place CLSM will be ready to pave over in 2 to 6 hours.
- (5) Excavatable Strength - Minimum of 20 pounds per square inch (psi) at 3 days and 30 psi at 28 days; Maximum of 100 psi at 28 days.
- (6) Flow Test - Fill 3-inch diameter x 6-inch high open ended cylinder to the top with material and level. Lift cylinder straight up. Material spread should be at least 8-inches in diameter.

Any deviations observed by the inspector in conflict with the above processes shall include adequate findings in accord with Section 7.13 A of these regulations.

- 1.5 SUBGRADE: The subgrade is defined as the top one (1) foot of the soil profile at finished grade prior to placing the pavement. This top one (1) foot of soil will consist of: (a) compacted fill placed for embankments as outlined in Item 1.3; (b) undisturbed soils in the transitional areas from cut to fill immediately below the topsoil; or (c) undisturbed soils at depths greater than 3 feet below the original ground surface in cut areas. The top one (1) foot of subgrade comprised of clayey soils or granular soils that exhibit a well defined moisture density curve shall be compacted to 98 percent of maximum density as determined by the standard Proctor moisture-density test (ASTM D698-91 or AASHTO T-99) or 87 percent of maximum density as determined by the modified Proctor moisture-density test (ASTM D1557-91 or AASHTO T-180) within two (2) percent of optimum moisture content on the dry side of the curve or three (3) percent of optimum moisture content on the wet side of the curve immediately prior to placing the pavement. This specification is similar to the compaction requirements in compacted fill areas since

the embankment shall be compacted to 95 percent or 87 percent of maximum density as determined by the standard Proctor or modified Proctor moisture-density test, respectively. Clean granular soils that do not exhibit well-defined moisture density curves shall be compacted to 75 percent relative density (ASTM D4253-95 and ASTM D4254-91). In transitional areas from cut to fill, the soils have been subject to seasonal changes of freezing and thawing and wetting and drying. These soils will exist at moisture contents well above optimum moisture content and at densities on the order of 60 to 80 percent of maximum density (ASTM D698-91). These soils shall be scarified, aerated, and dried in order to obtain the specified percent compaction for subgrade. Soils in cut areas, three (3) feet below original grade, will exist at moisture contents above optimum moisture content and at densities on the order of 90 percent of maximum density (ASTM D698-91). These soils shall be scarified, aerated, and dried in order to obtain the specified percent compaction for subgrade.

Subgrade Underdrainage Systems - In order to maintain maximum densities of subgrade comprised of clayey soils, granular soils or other clean granular soils, four (4) - inch minimum perforated pipe underdrainage systems shall be installed and connected to approved storm sewer systems at each of the following locations and in accord with details within Appendix "C":

- (1) interconnecting street catch basins opposite each other and entrance to cul-de-sacs;
- (2) extending from any street catch basin perpendicular for full width beneath street pavement and capped with a clean out;
- (3) extending perpendicular from any street catch basin to any utility trench within the limits of the public right of way;
- (4) extending from any street catch basin when excavations within subgrade are replaced with clean granular soils; and
- (5) extending from any street catch basin to intercept a water table generated from a natural spring or other damaging discharge observed during grading operations.

All connections to street catch basins shall be approved by the inspector. Grout or mortar used shall be in conformance with Section 601 of KYDOT standard specifications.

Any soft or yielding areas, resulting from high moisture content that are encountered at the time of construction shall be scarified, aerated, and dried to reduce the moisture content nearer to optimum moisture content, then recompact to the specified density.

The subgrade shall be shaped to plan elevation and cross-section. Immediately prior to placing the concrete, the subgrade shall be checked for conformity with the cross-section shown on the plans by means of an approved template on the side forms. If necessary, the materials shall be removed or added, as required, to bring all portions of the subgrade to correct elevations. The subgrade shall be thoroughly compacted and again checked with the template. Concrete shall not be placed on any part of the subgrade which has not been checked for correct elevation. The subgrade shall be clean of loose or wet material prior to placing concrete.

Prior to placing the concrete, the Contractor shall proofroll the compacted subgrade with a piece of heavy rubber tired equipment, such as a single-axle dump truck having a minimum gross weight of ten (10) tons or 20,000 lbs. The Inspector shall observe the proofrolling for consistency. Areas which are subject to excessive pumping or rutting shall be reworked and recompacted as described above.

- 1.6 **EQUIPMENT FOR COMPACTION OF BACKFILL, EMBANKMENT, AND SUBGRADE:** Any compaction equipment capable of producing the required embankment and subgrade densities, without lamination, will be permitted. Clayey type or cohesive soils shall be compacted with a kneading type compaction equipment, such as a sheepsfoot roller. Cohesionless soils shall be compacted with vibratory type equipment, such as a vibrating plate or roller. All compaction equipment shall be in good condition and shall be operated efficiently to assure uniform compaction.
- 1.7 **SUBGRADE FOR SIDEWALKS AND DRIVEWAYS:** Subgrade for driveways shall comply with Item 1.5. except soil density tests are not required. Cohesive soils or lean concrete shall be used under driveways (i.e., apron and sidewalk portion of driveway minimum eight (8) feet back of curb for single or two-family or nine (9) feet for multi-family or commercial), provided compaction is performed per Item 1.6. For sidewalks between driveways, subgrade of cohesive soils shall be uniformly compacted per Item 1.6. Cohesionless or granular soils may be used as a base on subgrade for sidewalks between driveways provided base thickness does not exceed four (4) inches or thickness equivalent to that of the sidewalk and compacted per Item 1.6
- 1.8 **EQUIPMENT OPERATED ON STREETS:** The contractor shall be permitted to operate only pneumatic tired equipment over any paved street surfaces and shall be responsible for correcting any damage to street surfaces resulting from the contractor's operation. Paved streets, adjacent to new development, shall have all loose soil or mud removed at the end of each day's work.
- 1.9 **UTILITIES:** Special precautions shall be taken by the contractor to avoid damage to existing overhead and underground utilities. Before proceeding with the work, the contractor shall confer with all public or private companies, agencies, or departments that own or operate utilities in the vicinity of the construction work. The contractor shall be diligent in his efforts to use every possible means to locate existing utilities.
- 1.10 **SOIL DENSITY TESTS:** Soil density tests, including moisture-density tests (ASTM D698-91 or ASTM D1557-91) and field density tests (ASTM D1556-90 or ASTM D2922-90 or ASTM D4253-95 and ASTM D4254-91, where applicable) are required to determine the percent compaction in accord with the following:
- (1) Embankments - a minimum of one (1) test for each three (3) feet in elevation per 400 lineal feet or every 2500 cubic yards, or fraction thereof, of embankment section;
 - (2) Backfill utility trenches - a minimum of one (1) test for each two (2) feet in elevation per 100 feet, or fraction thereof, of utility trench open cut

beneath street subgrade and within the limits of the public right of way;
and

Where depths of trenches are more than (5) feet and worker safety is at risk, the inspector shall observe the compaction process in layers with an appropriate type of compaction equipment and document observations until worker safety is assured when compaction testing, as required, is resumed.

- (3) Subgrades - a minimum of one (1) test per 100 lineal feet for streets 500 lineal feet or less or one (1) test per 200 lineal feet for streets over 500 lineal feet at each of the following locations, where applicable:
 - (a) compacted fill placed for embankments;
 - (b) undisturbed soils in transitional areas from cut to fill immediately below the topsoil; and
 - (c) undisturbed soils at depths greater than 3 feet below the original ground in cut areas.

All soil density testing shall be at the expense of the developer. The results of these tests shall be mailed directly to the developer, design engineer, inspector, and the contractor. The results of all soil testing shall be compared to the densities, stated in Items 1.3, 1.4, and 1.5 of these regulations. Any deficiencies found in construction work must be remedied in the field or resolved between the developer, contractor, and inspector, subject to approval by a qualified/recognized geotechnical engineer.

Any deviations observed by the inspector in conflict with frequency of soil density testing shall include findings in accord with Section 7.13 A of these regulations.

ITEM 2.0 MATERIALS

Concrete shall be composed of Portland Cement, air-entraining agent, aggregates, and water.

- 2.1 **PORTLAND CEMENT:** Cement of the type specified shall conform to requirements of the current ASTM specifications including Portland Cement Type I or Type III - High Early Strength (Designations C 150, C 175 or C 595). Cement, which for any reason has become partially set or which contains lumps of caked cement, shall be rejected. Either packaged or bulk cement may be used.
- 2.2 **AIR-ENTRAINING AGENT:** Air-entraining agents shall conform to the requirements of the current ASTM specifications for air-entraining admixtures for concrete (Designation C 260).
- 2.3 **ADMIXTURES FOR CONCRETE:** Chemical admixture of the type specified shall conform to requirements of the current ASTM specifications for Admixtures of Type A thru and Type E (Designation C 494). No pozzolans (Fly Ash) will be allowed as substitute for cement.

- 2.4 **AGGREGATES:** All aggregates for concrete shall meet the current standard requirements for concrete pavements of the Kentucky Department for Transportation, Bureau of Highways, or the current ASTM specification for concrete aggregates (Designation C 33).

Aggregates shall be so handled that moisture content and gradation are reasonably uniform and do not change appreciably from batch to batch or hour to hour.

No aggregates shall be used which have become contaminated or intermixed. Frozen aggregates or aggregates containing frozen lumps shall be thawed before use.

- 2.5 **WATER:** Water used in mixing or curing concrete shall be clean and free from injurious amounts of oil, acids, salt, alkali, or organic materials or other substances harmful to concrete. Normally, water from public supplies, which is suitable for drinking, is satisfactory.

- 2.6 **REINFORCING STEEL:** Reinforcing steel, if specified, shall conform to current Standard Specifications of the Kentucky Department of Transportation, Bureau of Highways.

- 2.7 **JOINTS:**

2.7.1 **EXPANSION JOINTS:** Expansion joints shall be non-extruding pre-formed joint fillers and shall conform to current Standard Specifications of the Kentucky Department of Transportation. The selection of the type will be at the contractor's option.

2.7.2 **JOINT SEALING COMPOUND:** The material used for filling and sealing cracks and/or joints shall be W. R. Meadows Sealtight #164 - Hot Pour Rubber Asphalt Sealer, W. R. Meadows Sealtight Hi-Spec Hot Pour Joint Sealing Compound or approved equal (AASHTO M 173).

ITEM 3.0 BATCHING

Batching shall conform to Kentucky Department of Transportation, Bureau of Highways Specification 601.08 through 601.18.

- 3.1 **STRENGTH OF CONCRETE:** Finished concrete shall attain a minimum expected strength at 28 days of 4000 pounds per square inch compressive strength and/or 570 pounds per square inch flexural strength "modulus of rupture".

Except for sidewalks and driveways, at least three (3) test cylinders shall be made for each day's placement for each 100 cubic yards, or portion thereof, by a recognized testing laboratory. One (1) cylinder shall be broken at seven (7) days and two (2) cylinders at 28 days. The results of these tests shall be sent directly to the Inspector, Design Engineer, Contractor, and concrete supplier.

The fabricating, curing, breaking, and reporting the test cylinders, slump test, and air content test shall be made at the contractor's expense.

- 3.2 **PROPORTIONING CONCRETE:** The proper proportions of cement, water, and aggregates shall be determined in accordance with ACI Standard 613, "Recommended Practice for Selecting Proportions for Concrete", or the Portland Cement Association booklet, "Design and Control of Concrete Mixtures", latest editions.

The entrained air shall be obtained by using an air-entraining agent. All concrete shall be air-entrained in accordance with the following:

MAXIMUM SIZE OF AGGREGATE (INCHES)	AIR CONTENT PERCENT BY VOLUME
1-1/2, 2, 2-1/2	5 +/- 1%
3/4, 1	6 +/- 1%
3/8, 1/2	7-1/2 +/- 1%

- 3.3 **CONSISTENCY:** The slump of the concrete shall not exceed four (4) inches. Consistency shall be measured as described in the current ASTM Standard Method of Slump Test for Consistency of Portland Cement Concrete (Designation C 143 or Method of Test for Ball Penetration for Portland Cement Concrete, Designation C-360).

- 3.4 **READY-MIXED CONCRETE:** All ready-mixed concrete shall be furnished in accordance with current ASTM specifications for ready-mixed concrete (Designation C 94 or AASHTO M 157). Any concrete, which is not plastic and workable when it reaches the subgrade, shall be rejected.

3.4.1 **TIME OF DELIVERY:** Concrete shall be delivered and discharged from a truck mixer or agitator truck within a period of one and one-half (1-1/2) hours at air temperatures up to eighty-five (85) degrees Fahrenheit, and one (1) hour at air temperatures higher than eighty-five (85) degrees Fahrenheit, after introduction of the water to the cement and aggregates or the cement to the aggregates. Delivery tickets shall have this time clearly shown thereon, and the inspector shall check to be certain that delivery is made within the period specified.

3.4.2 **TYPE OF DELIVERY EQUIPMENT:** Concrete shall be delivered in truck mixers or agitator truck (i.e., trucks providing mechanical agitation by revolving drums or revolving blades in a stationary drum) operated after time required for thorough mixing of the concrete at the speed designated by the manufacturer as agitating speed.

- 3.5 **JOB-MIXED CONCRETE:** Job-mixed concrete shall be mixed in a drum mixer, which shall conform to the concrete paving mixer standards of the Mixer Manufacturers Bureau of the Association General Contractors of America. The mixer shall be capable of combining the aggregates, cement, and water into a thoroughly mixed and uniform mass within the specified time and of discharging the material without segregation.

The entire contents of the drum shall be discharged before recharging. The volume of the mixed materials per batch shall not exceed the manufacturer's guaranteed capacity of the mixer.

3.5.1 **TIME OF MIXING:** The mixing of each batch shall continue for not less than one minute after all materials, except water, are in the mixer. The mixer shall rotate at the rate recommended by its manufacturer. The mixer shall be provided with a batch timing device which shall be subject to inspection and adjustment by the inspector.

3.6 **ADJUSTING SLUMP OF CONCRETE:** Measured amounts of water can be added. After adding water, an additional slump test must be made.

ITEM 4.0 MEASURING AIR CONTENT

The air content shall be measured in accordance with ASTM Method of Test for Air Content of Freshly Mixed Concrete by the Pressure Method (Designation C 231) or ASTM Method of Test for Air Content of Freshly Mixed Concrete by the Volumetric Method (Designation C 173).

ITEM 5.0 FORMS

Except for slipform paving methods, fixed forms may be made of wood or metal and shall have a depth equal to or greater than the prescribed edge of thickness of the pavement. Each section or form shall be straight, free from bends or warps.

The method of connections between the form sections shall be such that the joint thus formed is tight and free from movement in any direction.

Forms shall be of such cross-sections and strength and so secured as to resist the pressure of the concrete when placed, and the impact and vibration of any equipment, which they support without springing or settlement.

5.1 **SETTING FORMS:** The subgrade under the forms shall be compacted and shaped so that the form set shall provide the specified elevation. The supply of forms shall be sufficient to permit their remaining in place for sufficient time so, when removed, the concrete will not be displaced. All forms shall be cleaned and oiled each time they are used.

5.2 **GRADE AND ALIGNMENT:** The alignment and grade elevation of the forms shall be checked by the contractor immediately ahead of concrete placement and necessary corrections will be made. Any forms that have been disturbed or subgrade that has become unstable shall be corrected and forms reset and rechecked. Any variations in grade and alignment shall be subject to approval of the Design Engineer and Inspector prior to placing concrete.

ITEM 6.0 PLACING CONCRETE

The concrete shall be mixed in quantities required for immediate use and shall be deposited on the subgrade to the required depth and width of the construction lane in successive batches and in a continuous operation, without the use of intermediate forms or bulk-heads. The concrete shall be placed as uniformly as possible, in order to minimize the amount of additional spreading necessary. While being placed, the concrete shall be vibrated and compacted with suitable tools, so that the formation of voids or honeycomb pockets is prevented.

No concrete shall be placed around manholes or other structures until they have been brought to the required grade and alignment. Additional tamping and compaction will be required after raising manholes.

6.1 **COLD WEATHER CONCRETING:** All concrete placements shall conform to the American Concrete Institute Specification ACI 306. Concrete may be placed when the contact surface temperature is thirty - five (35) degrees Fahrenheit or higher. No concrete shall be placed upon frozen subgrade. However, if subgrade has been protected from freezing and concrete temperature for mixed and placed slabs (less than 12-inch thickness) is maintained at 55 degrees Fahrenheit or higher and protected (e.g., insulating blankets, etc.), concrete may be placed regardless of the ambient temperature. Concrete placed on non-saturated subgrade shall be protected from freezing for a period up to three (3) days or until concrete reaches a compressive strength of 500 psi. Concrete placed on saturated subgrade shall be protected from freezing for a period up to three (3) days or until concrete reaches a compressive strength of 3500 psi.

6.2 **HOT WEATHER CONCRETING:** Except by approval of the inspector, concrete placing shall cease if the temperature of the plastic concrete cannot be maintained at ninety (90) degrees Fahrenheit or lower.

To facilitate the placement of concrete in hot weather, a retarding chemical admixture Type B or D, in conformance with ASTM C-494, may be used.

ITEM 7.0 CONSOLIDATING AND FINISHING

The pavement shall be struck off and consolidated with a mechanical finishing machine, vibrating screed, or by hand-finishing methods. A slipform paver may also be used. When a mechanical finishing machine is used, the concrete shall be struck off at such a height that after consolidation and final finishing, it shall be at the elevation as shown on the plans.

The finishing machine shall be provided with a screed, which will consolidate the concrete by pressure, vibration or both. The concrete shall be brought to a true and even surface, free from rock pockets. The edge of the screeds along the curb line may be notched out to allow for sufficient concrete to form the integral curb. Hand-finishing tools shall be kept available for use in case the finishing machine breaks down.

When hand-finishing is used, the pavement shall be struck off and consolidated by a vibrating screed to the elevation as shown on the plans. When the forward motion of the vibrating screed is stopped, the vibrator shall be shut off; it shall not be allowed to idle on the concrete.

- 7.1 **SCRAPING AND STRAIGHTEDGING:** The pavement may be required, by the inspector, where applicable, to be scraped with a straightedge, equipped with handles long enough to permit it to be operated from the edge of the pavement.
- When irregularities are discovered, they shall be corrected by adding or removing concrete. All disturbed areas shall be floated with a wooden or metal float not less than three (3) feet long and not less than six (6) inches wide and again straight-edged.
- 7.2 **EDGING:** Before final finishing is completed, and before the concrete has taken its initial set, the edges of the slab and curb shall be carefully finished with an edger.
- 7.3 **FINAL SURFACE FINISH:** A burlap drag or medium broom shall be used as the final finishing method for concrete pavement. The drag shall be at least three (3) feet in width and long enough to cover the entire pavement width. It shall be laid on the surface of the pavement and dragged forward in the direction in which the pavement is being laid. If a broom finish is used, the brooming shall be drawn from the center to the edge of pavement using overlapping strokes to produce surface corrugations of uniform appearance about 1/16th inch in depth. The curb shall have the same final finish as the pavement.

The final surface of the concrete pavement and curb shall have a uniform gritty texture, and true to the grades and cross-sections shown on the plans.

ITEM 8.0 INTEGRAL CURB

Curbs shall be required along the edges of all street pavement where shown on the plans and shall conform to cross sections. Curbs may be constructed simultaneously with the pavement with extrusion equipment, hand formed immediately after the finishing operation, or built as a separate construction operation.

The integral vertical and rolled curb shall be constructed with or immediately following the finished operation. Special care shall be taken so that the curb construction does not lag the pavement construction and form a "cold joint".

When integral vertical curbs are required along the edges of all street pavement, depressed curbs two (2) inches above gutter line shall be provided at all driveway entrances and at such other locations as designated on the approved plans.

In placing concrete curb, sufficient spading shall be done to secure adequate bond with paving slab and eliminate all voids within and back face of the curb.

Curbs shall be formed to the cross-section in accordance with Appendix "C".

ITEM 9.0 CURING

Concrete shall be cured by protecting it against loss of moisture, rapid temperature change, from rain, flowing water, and mechanical injury for a period of not less than five (5) days from the beginning of the curing operation. Moist curing, waterproof paper, white pigmented liquid

membrane compound, or a combination thereof, may be used for curing. Immediately after finishing operations have been completed, the entire surface of the newly placed concrete shall be covered by the curing medium which is applicable to local conditions and approved by the inspector.

The edge of concrete slabs exposed by the removal of forms shall be protected immediately to provide these surfaces and to prevent injury to concrete edges.

The covering material shall be kept free of any substances, which may be detrimental to the surface of the concrete. The initial curing medium shall be effective and shall be applied so as to prevent checking, cracking, and the appearance of dry spots in the surface of the concrete. The contractor shall have the equipment needed for adequate curing at hand and ready to install before actual concrete placement begins. In all cases in which the curing medium requires the use of water, the curing shall have prior right to all water supply. Failure to provide sufficient cover material of the type selected, failure to maintain saturation for the entire curing period in the moist-curing methods, lack of water to adequately care for both curing and other requirements, or other failures to comply with curing requirements shall be cause for immediate suspension of concreting operations.

- 9.1 **MOIST CURING:** Moist curing shall be accomplished by covering of burlap, cotton mats, or other approved fabric mat used singly or in combination.

Curing mats shall be thoroughly wet when applied and kept continuously wet and in intimate contact with the pavement surface for the duration of the moist curing period. Other fabric mats shall conform in design and shall provide a curing medium at least equal to cotton mats. Cotton mats, other fabric mats, and burlap mats and burlap strips shall be furnished in the widths or lengths, after shrinkage, required to cover the entire width and edges of the pavement lane. Mats or burlap shall be lapped at joints between adjacent sheets to prevent drying at this location. Moist curing, when used as initial curing, shall be continued for not less than twenty-four (24) hours. Type and weight of cotton mats for curing concrete shall conform to ASTM C-440 or AASHTO M-73. Burlap strips shall conform to AASHTO M-182.

- 9.2 **WATERPROOF PAPER AND POLYTHENE SHEETING CURING:** The surface of the concrete shall be wetted with a fine spray of water and then covered with the waterproof paper or sheeting. The paper or sheeting shall be in pieces large enough to cover the entire width and edges of the slab and shall be lapped not less than twelve (12) inches. Paper or sheeting shall be adequately weighted to prevent displacement or billowing due to wind. Paper or sheeting folded down over the side of the pavement widths shall be secured by a continuous bank of earth. Tears or holes appearing in the paper or sheeting during the curing period shall be immediately repaired.

- 9.3 **LIQUID MEMBRANE CURING COMPOUND:** Pigmented liquid membrane curing compound shall meet the specifications under ASTM C 309 classified as Type 1-D translucent with fugitive dye, Type 2 - white pigmented or approved equal. The curing compound must be applied to cover the surface completely and uniformly at a rate which will achieve the performance requirement specified in AASHTO specifications M 148 or ASTM Designation C 309. This method of curing shall be applied immediately behind

the final finishing operation or after the initial curing when a combination of methods are used. Failure to provide complete and uniform coverage at the required rate will be cause for discontinuance of this method of curing and the substitution of one of the other approved methods. The compound shall be kept agitated to prevent the pigment from settling. Special care shall be taken to apply the curing compound to the pavement edges immediately after the forms have been removed.

- 9.4 ADJACENT WORK: Grading operations for preparation of subgrade for asphalt streets adjacent to “plastic or green” concrete curb shall be suspended for at least twenty - four (24) hours after initial curing operations have been completed. Extreme caution shall be used with machinery including vibratory equipment in order to prevent chipping or fracture of such new concrete curb pavements. Any damaged sections of curb shall be removed and replaced prior to start of the next phase of work.

ITEM 10.0 PAVEMENT JOINTS (all joints shall be constructed as per details in Appendix "C")

Concrete pavement shall include expansion, contraction, and longitudinal joints. Transverse joints may be expansion and contraction type joints which shall be continuous across the pavement lane including the curb. Longitudinal joints are parallel to the pavement lanes. Construction joints are necessary when the placement of concrete is delayed. The location of transverse construction joints may be either planned (coincidental with a contraction joint) or emergency (not coincidental with a contraction joint). In general, the location of longitudinal joints shall be centered between pavement lanes except for street widths 30 feet and wider.

The placement and construction of all pavement joints shall comply with joint details in Appendix "C" and shall be shown or referenced on the Improvements Drawings in accord with the following criteria:

10.1 EXPANSION JOINTS

Expansion joints shall be Type 1. Filler material shall conform to Item 2.7.1 of these regulations and extend the entire width of the pavement. The filler shall be held accurately in place during the placing and finishing of the concrete by a bulkhead, a metal channel cap or other approved method. Expansion joints shall be installed at the following locations: (1) at all street intersections at the point of curvature of the turning radii entering the intersection; and (2) at cul-de-sacs or turnarounds at the point of curvature of the first turning radii approaching the turn-around. In no case shall the expansion joint spacing exceed 150 feet.

No concrete shall be left above the expansion material or across the joint at any point. Any concrete spanning the ends of the joint next to the forms shall be carefully cut away after the forms are removed.

Before the pavement is opened to traffic, the groove above the filler shall be cleaned and sealed with joint sealing material specified in Item 2.7.2 of these regulations.

10.2 CONTRACTION JOINTS

Transverse joints shall be Type 2. Sawed joints shall be equal to a depth of one-fourth (1/4) of the pavement thickness as the minimum established standard continuous across the slab including additional depth at the integral curb faces. Such joints may also be grooved with a metal jointing tool to a depth of one and one half (1-1/2) inches including additional depth and special treatment at integral curb faces to control cracking. Other joint depths used with alternate pavement designs including stabilized pavement subbases shall be shown on the plans and reviewed per industry standards.

In no case shall the contraction joint be spaced at intervals greater than a distance of fifteen (15) feet between joints for integral curb concrete pavement. For concrete curb used with asphalt pavement, contraction joints shall be spaced at intervals not greater than ten (10) feet.

Where sawed joints are specified, they shall be sawed within a time frame of between four (4) hours and eight (8) hours following placement of each pavement section. However, depending upon temperature, weather conditions, and other factors affecting setting times, variations to these time frames may be required to ensure that joints are sawed early enough to control cracking, but late enough to prevent any damage by blade action to the slab surface and to the concrete immediately adjacent to the joint.

10.3 CONSTRUCTION JOINTS

Transverse construction joints shall be used wherever the placing of concrete is suspended for more than thirty (30) minutes. A transverse construction joint shall be Type 3, with smooth bars (one end lubricated) if the joint occurs at the location of a contraction joint. A transverse construction joint shall be Type 4 with deformed tie bars (both ends bonded) if the joint occurs at any other location. Both Type 3 and Type 4 joints shall be butt type construction formed. In the case of integral curb concrete pavement where construction joints are sawed they shall be saw cut full depth where no vertical face of concrete is undermined creating a void under the pavement. In the case of concrete curb and gutter used with asphalt pavement, special care should be taken to ensure that all surfaces including the joint are uniform and result in the same integrity as an integral curb concrete placement.

10.4 LONGITUDINAL JOINTS

Longitudinal joints between lanes shall be Type 6 of the tied construction type. An alternative longitudinal joint Type 7 may be used with slip-form paving operations. As an option to drilling diagonal bars in Type 7, bent bars may also be injected in fresh concrete before it's initial set. Following subgrade preparation and testing, bent bars shall not be straightened until the concrete has cured sufficiently to enable bending without fracture of concrete slab as determined by the inspector. The location of longitudinal joints shall be centered between pavement lanes and coincide with lane markings wherever possible, except for street widths of thirty (30) feet and wider where joints shall be located at equal intermediate locations. In these cases, longitudinal joints may be sawed and shall be Type 5.

10.5 INTEGRAL CURB JOINTS

In the construction of transverse joints, special care must be taken to ensure that all transverse joints extend continuously through the pavement and curb per Items 10.2 and 10.3 of these regulations.

ITEM 11.0 TIE BARS

All tie bar reinforcement for concrete pavement shall conform to Item 2.6 of these regulations. All tie bars shall be deformed bars for Types 4, 5, 6, and 7, and plain or smooth bars for Type 1 and 3, as detailed in Appendix "C".

ITEM 12.0 JOINT SEALER

Pavement joint sealer shall be as specified in Item 2.7.2 of these regulations. Application of joint sealer shall be as follows:

Material must be melted in a double boiler, oil jacketed melter equipped with a mechanical agitator, pump, gas pressure gauges, and separate temperature thermometers for both oil bath and melting vat, with accessible control valves and gauges.

On start up of melter, raise the oil bath temperature, not to exceed 450 degrees (F). Add small quantities of crack filler material to the melter and, while continuously agitating, add additional material as needed. Control material temperature at 380 degrees (F). Do not exceed 400 degrees (F) at start up.

The sealing and filling of joints and/or cracks may be done at air temperature of 40 degrees (F) or higher. For best results, cracks should be filled to a depth of 1/4 inch below the surface. Where necessary to limit the depth of the sealant, use cotton or kraft rope inserted to the correct depth of the cleaned joint or crack.

Small quantities of unused material remaining in the melter may be remelted and used the following day.

ITEM 13.0 STRUCTURES ENCOUNTERED IN THE PAVED AREA

13.1 MANHOLES AND CATCH BASINS: All manholes and catch basins encountered in the areas to be paved shall be raised or lowered to the surface of the new pavement. Catch basins may be separated from the pavement and curb by boxing out around basin. See Appendix "C".

ITEM 14.0 PROTECTION AND OPENING TO TRAFFIC

Traffic shall be excluded from the pavement by erecting and maintaining barricades and signs until the concrete is at least seven (7) days old or has attained a compressive strength of 3,500 pounds per square inch and/or a flexural strength of 550 per square inch using Type I Normal Cement certified by a qualified/recognized geotechnical engineer. Other protection and opening

to traffic decisions on other pavement designs using Type III High Early Strength Cement shall be reviewed per industry standards. This traffic restriction shall apply to the contractor's vehicles, as well as general traffic. As soon as curing and sealing are completed, the contractor shall clean up the pavement free from all debris.

ITEM 15.0 CURB, GUTTER, SIDEWALK, AND DRIVEWAYS

Construction of curb, gutter, sidewalk, and driveways shall require the same care as the street pavement. The preceding requirements shall apply, where pertinent, to the construction of curb, gutter, sidewalks, and driveways within the right-of-way. In addition, sidewalks or driveways shall be constructed so that the transverse joint spacing shall be equal to the width of the sidewalk or driveway, but in no case shall the transverse joint spacing for driveways exceed twelve (12) feet and not greater than five (5) feet for sidewalk spacing. Sidewalks and driveways, within the right-of-way, shall be constructed with a pavement thickness of at least four (4) inches and increased to five (5) inches when included as a part of a driveway. Driveways shall be a minimum of five (5) inches in thickness within the right-of-way. (see Appendix "C" for typical section details). Commercial and industrial entrances will require sidewalk thickness conforming to driveway pavement thickness.

ITEM 16.0 PAVEMENT THICKNESS

Pavement thickness for each type street classification shall be as provided in Table A-1. Streets that are subjected to exceptionally heavy truck traffic shall require a more complete detailed analysis by the subdivider's engineer and approved by the planning commission's duly authorized representative.

All arterial streets shall be designed in accordance with the requirements of the Kentucky Department of Transportation.

- 16.1 TOLERANCE IN PAVEMENT THICKNESS: Deficiency in pavement thickness determined by drilling or coring new concrete pavement shall not exceed 0.20 inches. When thickness of pavement is deficient by more than 0.20 inches, such areas shall be removed and/or replaced unless otherwise determined by the inspector and a qualified registered professional engineer.
- 16.2 SURFACE TOLERANCE: The finished surface shall be tested for smoothness by use of a 10-foot long straightedge placed parallel to the centerline of the pavement in each wheel lane. Ordinates measured from the face of the straightedge to the surface of the pavement shall at no place exceed one-quarter inch. Areas that do not meet the required surface accuracy shall be clearly marked out and the Contractor shall, at his own expense, as required by the planning commission's duly authorized representative:
1. Grind down any areas higher than 1/4 inch but not more than 1/2 inch above the correct surface.
 2. Correct any areas lower than 1/4 inch but not lower than 1/2 inch below the correct surface by grinding down the adjacent areas.

3. When the deviation exceeds 1/2 inch from the correct surface, the pavement slab shall be broken out and replaced for a length, width and depth, which will allow the formation of a new slab of the required quality in no way inferior to the adjacent undisturbed slab.

TABLE A-1
 MINIMUM PAVEMENT THICKNESS FOR
 STREETS - PORTLAND CEMENT CONCRETE*

STREET CLASSIFICATION	PAVEMENT THICKNESS (inches)**
Local Streets Including Courts And Cul-De-Sacs (serving 50 lots or less)	7
Subcollector Or Local Streets (serving more than 50 lots)	8
Collector	9

* Streets shall be designed in accord with the typical street section details in Appendix "C".

** Where streets are to serve industrial or commercial areas, the pavement design shall be based on a study prepared by the subdivider's engineer projecting the type of vehicles using the street and traffic volumes, approved by the planning commission's duly authorized representative.

Note: Welded wire fabric or wire mesh for reinforcing concrete pavements shall not be required unless otherwise specified by the design engineer.

APPENDIX "B"

ASPHALT CONCRETE PAVEMENT FOR STREET AND DRIVEWAY CONSTRUCTION

The work covered by these specifications consists of furnishing all labor, equipment, and materials, and performing all operations in connection with the construction of asphalt concrete pavement, in accord with these specifications and the applicable Improvement Drawings.

The asphaltic concrete pavement work shall consist of multiple layers of asphaltic concrete with or without granular base and subbase courses, constructed on a prepared sub-grade in general conformity with the lines, grades and cross-sections shown on the plans.

ITEM 1.0 GRADING

This term shall consist of all grading above or below subgrade elevations of whatever nature required to bring the street to proper subgrade elevations, including necessary excavation for curb, gutter, sidewalk, construction of embankments, excavation and proper sloping of all cuts, and other work incidental thereto.

- 1.1 EXCAVATIONS: All excavations shall be made to approximate grade or subgrade elevations consistent with approved plans. Except for utility trenches, excavations shall not be steeper than a cut slope of 2.5 horizontal to 1 vertical unless otherwise approved by a qualified/recognized geotechnical engineer.
- 1.2 EXCAVATION BELOW SUBGRADE: Whenever excavations below subgrade elevation to remove spongy or unstable material, organic matter, or other materials is required, the contractor shall remove same and shall replace with compactable soils as per Item 1.3. The excavation can be backfilled with soils that were removed, provided they are clean clayey soils free of organic matter and other deleterious material, aerated and dried to near optimum moisture content, or clean clayey borrow soils that have moisture contents near optimum moisture content.
- 1.3 CONSTRUCTION OF EMBANKMENT: All surface vegetation and heavy root system shall be removed to eliminate all vegetation from the area upon which the embankment is to be constructed. Soils so removed shall not be used in construction of embankment. These materials shall be stockpiled and respread across scarified areas after the scarified areas have been brought to within inches of finished grade.

Embankments comprised of clayey soils including clayey granular soils that exhibit well defined moisture density curves shall be constructed of approved soils to approximate subgrade elevation in shallow level layers, 6 to 8 inches, within two (2) percent of optimum moisture content on the dry side of the curve or within three (3) percent of optimum moisture content on the wet side of the curve, compacted with an appropriate type of compaction equipment to a density not less than 95 percent of maximum density, as determined by the standard Proctor moisture-density test (ASTM D698-91 or AASHTO T-99) or 87 percent of maximum density as determined by the modified

Proctor moisture-density test (ASTM D1557-91 or AASHTO T-180). Clean granular soils that do not exhibit a well defined moisture density curve shall be compacted to at least 75 percent relative density (ASTM D4253-95 and ASTM D4254-91) Except as otherwise approved by a Qualified/Recognized Geotechnical Engineer, all soils placed in areas directly impacting public improvements shall be constructed to slopes no steeper than 2.5 (horizontal) to 1 (vertical) and flatter where possible for ease of maintenance.

- 1.4 **BACKFILL:** Clayey soils or granular soils shall be used to backfill utility trenches within the limits of the right of way. Under no conditions shall any backfill be flushed with water to obtain compaction.

Clayey backfill soils for trenches within the limits of the public right of way shall be placed in the shallow level layers, six (6) to eight (8) inches in thickness, and each lift shall be thoroughly and uniformly compacted with kneading-type compaction equipment such as a sheepsfoot roller or self-propelled compactor. Clayey backfill soils beneath pavements and within three (3) feet of the back of curb along either side of pavements shall be moisture-conditioned to within two (2) percent of the optimum moisture content on the dry side of the curve or three (3) percent of the optimum moisture content on the wet side of the curve, and shall be compacted to densities not less than 95 percent of the standard Proctor maximum dry density (ASTM D698-91), or 87 percent of the modified proctor maximum dry density (ASTM D1557-91). Clayey backfill soils within the limits of the right of way greater than three (3) feet beyond the back of curb along either side of pavements shall be moisture conditioned to within three (3) percent of the optimum moisture content on the dry side of the curve or seven (7) percent of the optimum moisture content on the wet side of the curve, and shall be compacted to densities not less than 90 percent of the standard Proctor maximum dry density (ASTM D698-91) or 82 percent of the modified Proctor maximum dry density (ASTM D1557-91).

Granular backfill soils for trenches within the public right of way shall be placed in shallow level layers, six (6) to eight (8) inches in thickness, and each lift shall be thoroughly and uniformly compacted with an appropriate type of compaction equipment. Granular backfill which exhibits a well defined moisture density curve shall be moisture conditioned to within two (2) percent of the optimum moisture content on the dry side of the curve or three (3) percent of the optimum moisture content on the wet side of the curve and shall be compacted to 95 percent of the standard Proctor maximum dry density (ASTM D698-91) or 87 percent of the modified Proctor maximum dry density (ASTM D1557-91). Clean granular soils that do not exhibit a well defined moisture density curve shall be compacted to at least 75 percent relative density (ASTM D4253-95 and ASTM D4254-91).

Controlled Low Strength Material (CLSM) also referred to as flowable fill, flowable mortar or lean mix backfill may be used in place of compacted clayey soils or granular soils to uniformly backfill sewer conduit or utility trenches, catch basins, manholes or other excavations. Material mixture shall conform to the following requirements unless approved as equal.

- (1) Materials and proportions - a) Cement - Type I and II; 0-50 not to exceed 75 pounds per cubic yard (lb/cu.yd.); b) Fly Ash - ASTM C-618 Class "C" or "F";

250 - 400 lb/cu.yd.; c) Concrete Sand; 2600 - 2900 lb/cu.yd.; and d) Water; 400-500 lb/cu.yd. Contractor shall be responsible for determining if proposed mixture is proprietary and indemnify the planning commission or any legislative body from any claims.

- (2) Mixing - Backfill should be transported by mixing truck to ensure proper suspension when placed. Constant agitation is required.
- (3) Construction - Flowable fill is a fluid material. Caution should be used when backfilling pipe that is subject to flotation. Anchoring pipe by placing backfill in 8 to 12-inch lifts until fluid head resides may be necessary. When used to backfill aluminum pipe, adequate separation such as a bituminous coating shall be required. Fill material shall extend from the top of compacted bedding or other backfill to bottom of pavement structure.
- (4) Settlement and hardening - To expedite settlement and hardening, bleed water shall appear on the surface within 5 to 10 minutes after placement. CLSM is not concrete and should not be rated on setting time. The material will achieve density as soon as water leaves the mixture. The time involved until the fill may be paved over varies with permeability of adjacent soils, temperature, humidity, and moisture in these soils. In most conditions, the in place CLSM will be ready to pave over in 2 to 6 hours.
- (5) Excavatable Strength - Minimum of 20 pounds per square inch (psi) at 3 days and 30 psi at 28 days; Maximum of 100 psi at 28 days.
- (6) Flow Test - Fill 3-inch diameter x 6-inch high open-ended cylinder to the top with material and level. Lift cylinder straight up. Material spread should be at least 8-inches in diameter.

Any deviations observed by the inspector in conflict with the above processes shall include adequate findings in accord with Section 7.13 A of these regulations.

- 1.5 **SUBGRADE:** The subgrade is defined as the top one (1) foot of the soil profile at finished grade prior to placing the pavement. This top one (1) foot of soil will consist of: (a) compacted fill placed for embankments as outlined in Item 1.3; (b) undisturbed soils in the transitional areas from cut to fill immediately below the topsoil; or (c) undisturbed soils at depths greater than 3 feet below the original ground surface in cut areas. The top one (1) foot of subgrade comprised of clayey soils or granular soils that exhibit a well defined moisture density curve shall be compacted to 98 percent of maximum density as determined by the standard Proctor moisture-density test (ASTM D698-91 or AASHTO T-99) or 89 percent of maximum density as determined by the modified Proctor moisture-density test (ASTM D1557-91 or AASHTO T-180) within two (2) percent of optimum moisture content on the dry side of the curve or three (3) percent of optimum moisture content on the wet side of the curve immediately prior to placing the pavement. This specification is similar to the compaction requirements in compacted fill areas since the embankment shall be compacted to 95 percent or 87 percent of maximum density as determined by the standard Proctor or modified Proctor moisture-density test,

respectively. Clean granular soils that do not exhibit well-defined moisture density curves shall be compacted to 75 percent relative density (ASTM D4253-95 and ASTM D4254-91). In transitional areas from cut to fill, the soils have been subject to seasonal changes of freezing and thawing and wetting and drying. These soils will exist at moisture contents well above optimum moisture content and at densities on the order of 60 to 80 percent of maximum density (ASTM D698-91). These soils shall be scarified, aerated, and dried in order to obtain the specified percent compaction for subgrade. Soils in cut areas, three (3) feet below original grade, will exist at moisture contents above optimum moisture content and at densities on the order of 90 percent of maximum density (ASTM D698-91). These soils shall be scarified, aerated, and dried in order to obtain the specified percent compaction for subgrade.

Subgrade Underdrainage Systems - In order to maintain maximum densities of subgrade comprised of clayey soils, granular soils or other clean granular soils, four (4) - inch minimum perforated pipe underdrainage systems shall be installed and connected to approved storm sewer systems at each of the following locations and in accord with details within Appendix "C":

- (1) interconnecting street catch basins opposite each other and entrance to cul-de-sacs;
- (2) extending from any street catch basin perpendicular for full width beneath street pavement and capped with a clean out;
- (3) extending perpendicular from any street catch basin to any utility trench within the limits of the public right of way;
- (4) extending from any street catch basin when excavations within subgrade are replaced with clean granular soils; and
- (5) extending from any street catch basin to intercept a water table generated from a natural spring or other damaging discharge observed during grading operations.

All connections to street catch basins shall be approved by the inspector. Grout or mortar used shall be in conformance with Section 601 of KYDOT standard specifications.

Any soft or yielding areas, resulting from high moisture content that are encountered at the time of construction shall be scarified, aerated, and dried to reduce the moisture content nearer to optimum moisture content, then recompact to the specified density.

The subgrade shall be shaped to plan elevation and cross-section. Immediately prior to placing the concrete, the subgrade shall be checked for conformity with the cross-section shown on the plans by means of an approved template on the side forms. If necessary, the materials shall be removed or added, as required, to bring all portions of the subgrade to correct elevations. The subgrade shall be thoroughly compacted and again checked with the template. Concrete shall not be placed on any part of the subgrade which has not been checked for correct elevation. The subgrade shall be clean of loose or wet material prior to placing concrete.

Prior to placing the concrete, the Contractor shall proofroll the compacted subgrade with a piece of heavy rubber tired equipment, such as a single-axle dump truck having a minimum gross weight of ten (10) tons or 20,000 lbs. The Inspector shall observe the

proofrolling for consistency. Areas which are subject to excessive pumping or rutting shall be reworked and recompactd as described above.

- 1.6 **EQUIPMENT FOR COMPACTION OF BACKFILL, EMBANKMENT, AND SUBGRADE:** Any compaction equipment capable of producing the required embankment and subgrade densities, without lamination, will be permitted. Clayey type or cohesive soils shall be compacted with a kneading type compaction equipment such as a sheepsfoot roller. Cohesionless soils shall be compacted with vibratory type equipment, such as a vibrating plate or roller. All compaction equipment shall be in good condition and shall be operated efficiently to assure uniform compaction.
- 1.7 **SUBGRADE FOR SIDEWALKS AND DRIVEWAYS:** Subgrade for driveways shall comply with Item 1.5 except soil density tests are not required. Cohesive soils or lean concrete shall be used under driveways (i.e., apron and sidewalk portion of driveway minimum eight (8) feet back of curb for single or two-family or nine (9) feet for multi-family or commercial) provided compaction is performed per Item 1.6. For sidewalks between driveways, subgrade of cohesive soils shall be uniformly compacted per Item 1.6. Cohesionless or granular soils may be used as a base on subgrade for sidewalks provided base thickness does not exceed four (4) inches or thickness equivalent to that of the sidewalk and compacted per Item 1.6.
- 1.8 **EQUIPMENT OPERATED ON STREETS:** The contractor shall be permitted to operate only pneumatic tired equipment over any paved street surfaces and shall be responsible for correcting any damage to street surfaces resulting from the contractor's operation. Paved streets adjacent to new development shall have all loose soil or mud removed at the end of each day's work.
- 1.9 **UTILITIES:** Special precautions shall be taken by the contractor to avoid damage to existing overhead and underground utilities. Before proceeding with work, the contractor shall confer with all public or private companies, agencies, or departments that own or operate utilities in the vicinity of the construction work. The contractor shall be diligent in his efforts to use every possible means to locate existing utilities.
- 1.10 **SOIL DENSITY TESTS:** Soil density tests, including moisture-density tests (ASTM D698-91 or ASTM D1557-91) and field density tests (ASTM D1556-90 or ASTM D2922-90 or ASTM D4253-95 and ASTM D4254-91, where applicable) are required to determine the percent compaction in accord with the following:
 - (1) Embankments - a minimum of one (1) test for each three (3) feet in elevation per 400 lineal feet or every 2500 cubic yards, or fraction thereof, of embankment section;
 - (2) Backfill utility trenches - a minimum of one (1) test for each two (2) feet in elevation per 100 feet, or fraction thereof, of utility trench open cut beneath street subgrade and within the limits of the public right of way;
and

Where depths of trenches are more than (5) feet and worker safety is at risk, the inspector shall observe the compaction process in layers with an appropriate type of compaction equipment and document observations until worker safety is assured when compaction testing, as required, is resumed.

- (3) Subgrades - a minimum of one (1) test per 100 lineal feet for streets 500 lineal feet or less or one (1) test per 200 lineal feet for streets over 500 lineal feet at each of the following locations, where applicable:
 - (a) compacted fill placed for embankments;
 - (b) undisturbed soils in transitional areas from cut to fill immediately below the topsoil; and
 - (c) undisturbed soils at depths greater than 3 feet below the original ground in cut areas.

All soil density testing shall be at the expense of the developer. The results of these tests shall be mailed directly to the developer, design engineer, inspector, and the contractor. The results of all soil testing shall be compared to the densities, stated in Items 1.3, 1.4, and 1.5 of these regulations. Any deficiencies found in construction work must be remedied in the field or resolved between the developer, contractor, and inspector, subject to approval by a qualified/recognized geotechnical engineer.

Any deviations observed by the inspector in conflict with frequency of soil density testing shall include findings in accord with Section 7.13 A of these regulations.

ITEM 2.0 PREPARATION OF EXISTING GRANULAR BASE COURSES FOR SURFACING

- 2.1 **DESCRIPTION AND GENERAL REQUIREMENTS:** In areas where granular base course has been placed as a previous stage of street or road construction, the contractor shall blade, shape, and compact the base course in conformance with the required dimensions, line, grade, and cross-section to permit completion of the paving work. When directed by the Inspector, additional base course aggregates shall be provided or excess aggregate removed and disposed of, by the Contractor, as to provide conformance with the required roadway section.
- 2.2 **THICKNESS OF SURFACING REQUIRED FOR EXISTING GRANULAR BASE COURSES:** The existing thickness of granular base comprises a portion of the required Design Thickness as specified in Item 4.2 Appendix "B" of these regulations.

ITEM 3.0 ASPHALT PAVEMENT

- 3.1 **DESCRIPTION AND GENERAL REQUIREMENTS:** This item shall consist of furnishing all materials and performing all construction procedures required to build an

asphalt pavement, on a prepared and approved subgrade, conforming to the requirements of these specifications and to the pavement design shown on the approved plans. It may include any, or all, but is not necessarily limited to, materials and methods specified under Item 3 only.

Asphalt pavement shall consist of an asphalt concrete surface course, or courses, constructed on a base course, or courses and/or subbase course, designed in compliance with the requirements of Item 4.2 of Appendix "B" of these regulations.

Successive layers of the pavement shall be offset from the edge of the underlying layer, a distance equal to the course thickness of the lower layer, except when abutting existing construction. When the asphalt layers of the pavement abut a building foundation, barrier curb, or similar vertical surface, the abutting surface shall be heavily painted with asphalt prior to construction of the asphalt course. The surface course shall be finished one-fourth (1/4) inch above adjacent flush construction to permit proper compaction.

3.2.1 ASPHALT CONCRETE SURFACE COURSE: Asphalt Concrete Surface Course materials and construction shall conform to the current requirements of the Kentucky Department of Transportation, Bureau of Highways, for Asphalt Concrete Surface and Binder (Section 401, 402). Surface course mixture composition shall conform to the requirements Surface and Binder as set forth in Table B-1. Minimum Asphalt Concrete Surface, Binder and Bases Courses Thickness shall be as stated in Table B-2 of these regulations. In order to prevent unnecessary damage to final asphalt concrete pavement from new building development, bituminous surface course application shall be delayed not less than nine (9) and no more than eighteen (18) months after completion of the asphalt base course unless otherwise approved by the planning commission's duly authorized representative. Prior to final paving, asphalt base course shall be checked for damage and repairs made, where necessary.

3.2.2 ASPHALT CONCRETE BASE COURSE: Asphalt Concrete Base Course materials and construction shall conform to the current requirements of the Kentucky Department of Transportation, Bureau of Highways, Specifications for Asphalt Concrete Base Course (Section 401, 403).

Composition requirements of the mixture shall conform to the gradation limits for Asphalt Concrete Base Course set forth in Table B-1. Asphalt content used shall fall within the range shown and shall be approved by the inspector.

3.2.3 CRUSHED AGGREGATE BASE COURSE:

3.2.3.1 DESCRIPTION: Crushed Aggregate Base Course, when provided for in the approved structural design of the pavement, shall consist of a granular layer constructed on prepared subgrade or subbase in accord with these

specifications and in conformity with the approved dimensions, lines, grades, and cross-sections.

3.2.3.2 **MATERIALS AND CONSTRUCTION METHODS:** Crushed Aggregate Base Course shall conform to all the current requirements for materials and construction methods of the Kentucky Department of Transportation for Dense Graded Aggregate Base Course as per Section 303.

3.2.4 **GRANULAR SUBBASE COURSE:**

3.2.4.1 **DESCRIPTION:** Subbase, when provided for in the approved structural design of the pavement, shall consist of a granular layer conforming to the following material and construction specifications.

3.2.4.2 **MATERIALS AND CONSTRUCTION METHODS:** Crushed Aggregate Subbase Course shall conform to all the current requirements for materials and construction methods of the Kentucky Department of Transportation for Dense Graded Aggregate Subbase Course as per Section 303.

3.2.5 **ASPHALT PRIME COAT:** Asphalt Prime Coat shall be applied to the surface of granular courses upon which asphalt base or surface courses will be constructed.

Asphalt Prime shall conform to the Kentucky Department of Transportation requirements for Cutback Asphalt Emulsion Primer Type L, as per Section 407. Prime shall be applied to the surface of granular base course at a rate of 0.25 to 0.50 gallons per square yard, as directed by the inspector, in conformance with requirements of the referred to specification.

3.2.6 **ASPHALT TACK COAT:** Tack Coat shall consist of SS-1h, meeting the current requirements of the Kentucky Department of Transportation. It shall, when directed by the inspector, be diluted with equal parts of water. Application equipment and procedure shall conform to the requirements of the Kentucky Department of Transportation for Tack Coats as per Section 407. Tack Coat shall be applied to the surface of asphalt courses that have become dusty or dry from traffic use at a rate of 0.10 gallons per square yard of the diluted SS-1h before the subsequent course is constructed or in other circumstances when the inspector so directs.

ITEM 4.0 DESIGN OF ASPHALT PAVEMENT STRUCTURE

- 4.1 DESCRIPTION: Asphalt pavement structures for subdivision streets shall be designed in conformance with the requirements of this specification. Thickness of the total pavement, and of component layers, shall be determined on the basis of Street Classification.
- 4.2 PAVEMENT THICKNESS REQUIREMENTS: Thickness of component layers of the pavement for streets within the right-of-way and of the total pavement structure shall be determined per Table B-2. Where streets are to serve industrial or commercial areas, pavement design shall be based on a study prepared by the subdivider's engineer projecting type of vehicles using said streets and traffic volumes, and approved by the planning commission's duly authorized representative.

ITEM 5.0 ADJUSTING MANHOLE TOPS

- 5.1 DESCRIPTION: The contractor shall raise or lower existing manhole tops to coincide with the finished grade elevation of the paving.

ITEM 6.0 JOINT SEALING COMPOUND

The material used for filling and sealing cracks and/or joints between concrete and/or asphalt shall be W. R. Meadows Sealtight #164 Hot Pour Rubber Asphalt Sealer or approved equal.

TABLE B-1

TABLE OF COMPOSITION LIMITS FOR BITUMINOUS CONCRETE

SIEVE SIZE	PERCENT PASSING BY WEIGHT		
	BASE	BINDER	SURFACE
1-1/2 inch	100		
1 inch	(2)		
3/4 inch	70 - 98	100	
1/2 inch	--	--	100
3/8 inch	44 - 76	57 - 85	80 - 100
No. 4	30 - 58	37 - 68	55 - 80
No. 8	21 - 45	25 - 52	35 - 60
No. 16	14 - 35	15 - 38	22 - 46
No. 50	5 - 20	5 - 20	5 - 21
No. 100	3 - 10	3 - 10	3 - 14
No. 200	--	--	2 - 7
Asphalt Content (1)	3.5 - 6.5	4.0 - 7.0	4 - 8

- (1) Percent by weight of the total mixture.
- (2) When the specified thickness of the Base course is 2 inches or less, either 100 percent of the aggregate shall pass the 1-inch sieve or the Contractor may request in writing to use Bituminous Concrete Binder. When the Contractor elects to use bituminous concrete binder in lieu of bituminous concrete base, all requirements for thickness and compaction (or density) will apply, the same as if bituminous concrete base was used.

TABLE B-2

THICKNESS REQUIREMENTS FOR ASPHALT PAVED STREETS

STREET CLASSIFICATION	PAVEMENT THICKNESS				
	TOTAL MINIMUM THICKNESS (METHOD 1)		TOTAL MINIMUM THICKNESS (METHOD 2)		
	SURFACE (INCH)	BASE (INCH)	SURFACE (INCH)	BASE (INCH)	GRANULAR SUBBASE (INCH)
Local (6)	2	2 @ 3"	2	3	6
Subcollector (7)	2	2 @ 3-1/2"	2	4	8
Collector	2	2 @ 4"	2	5	8

NOTES:

1. Methods 1 and 2 will produce approximately the same pavement quality and strength.
2. Selection of the method shall be at the design engineer's option.
3. Designations pertinent to surface and binder and base courses used in this table correspond to the Kentucky Department of Highways Standard Specifications for Road and Bridge Construction:

 Surface and Binder (State Highway Designation Sections 401, 402).

 Base (State Highway Designation Sections 401, 403) -- Each layer of bituminous concrete base shall be constructed to a compacted thickness no less than three inches nor more than five inches, unless otherwise directed by the inspector.

 Granular base or granular subbase for Method 2 shall conform to composition limits specified in Sections 3.0, A., 3. and 3.0, A., 4. Each layer of granular base or subbase shall be constructed to a compacted thickness no less than three inches nor more than eight inches, unless otherwise directed by the inspector.
4. Where streets are to serve industrial or commercial areas, the pavement design shall be based on a study prepared by the subdivider's engineer projecting the type of vehicles using the street and traffic volumes, approved by the planning commission's duly authorized representative.
5. Arterial streets shall be based on requirements of the Kentucky Department of Transportation.
6. Pavement thickness alternatives (Method 1 or 2) for local streets include courts and cul-de-sacs serving 50 lots or less.
7. Pavement thickness alternatives (Method 1 or 2) for subcollector streets include local streets serving more than 50 lots.

APPENDIX “C”

STANDARD CONSTRUCTION REQUIREMENTS AND DETAILS FOR STREETS,
SIDEWALKS, DRIVEWAYS, EROSION CONTROL, AND STORM DRAINAGE SYSTEMS

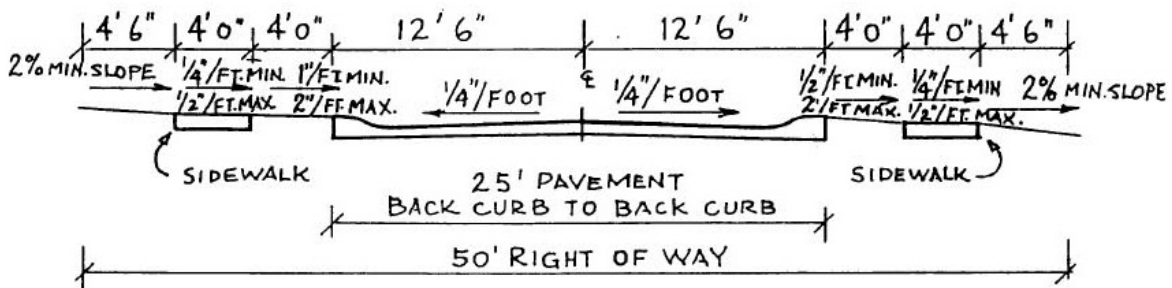
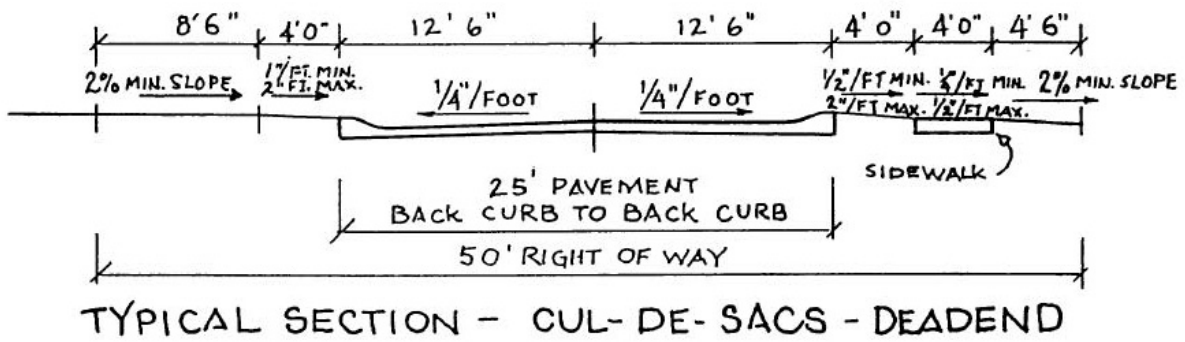
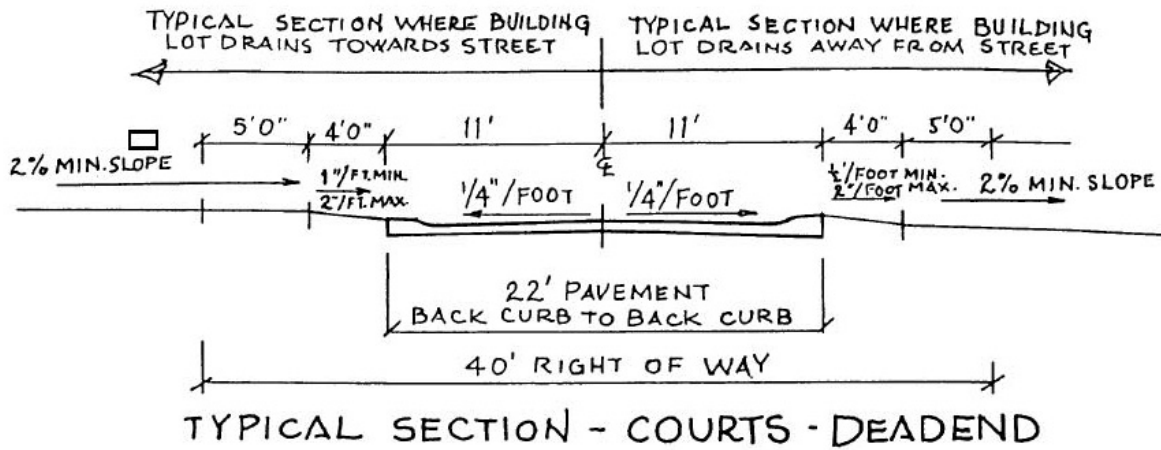

NOTE: SLOPES OUTSIDE OF STREET PAVEMENT ARE MINIMUM STANDARD EXCEPT FOR AREAS IN TRANSITION FROM UPWARD TO DOWNWARD SLOPES ALONG SAME SIDE OF STREETS.

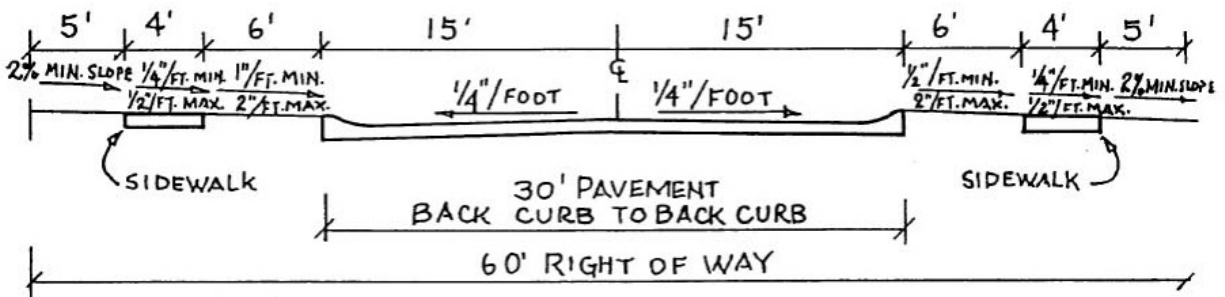
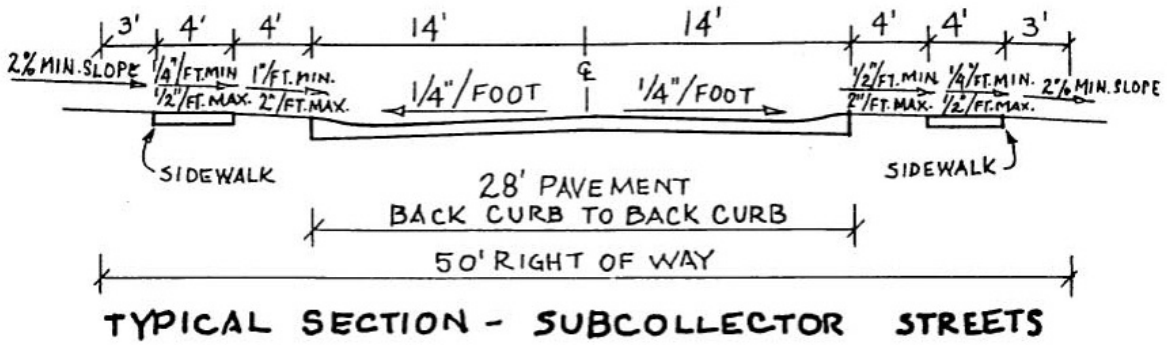

NOTE: SLOPES OUTSIDE OF STREET PAVEMENTS ARE MINIMUM STANDARD EXCEPT FOR AREAS IN TRANSITION FROM UPWARD TO DOWNWARD SLOPES SAME SIDE OF STREETS.

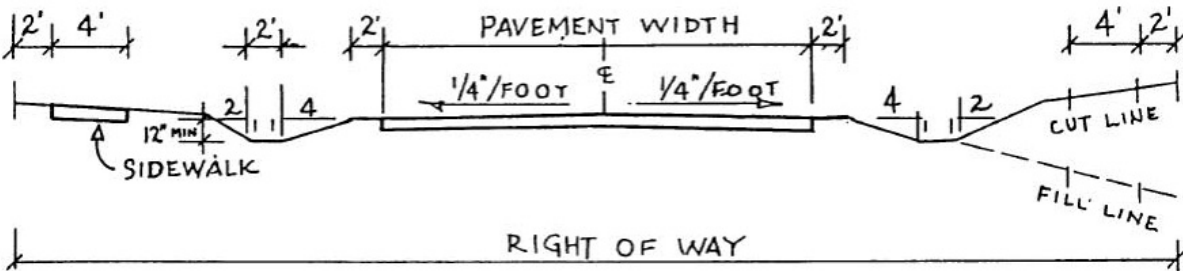

OPTION TO CURB AND GUTTER - ALL STREETS
FRONT YARD DEPTH - 50' MIN. LOT WIDTH - 100' MIN.

RESIDENTIAL DRIVEWAY APRON DETAILS

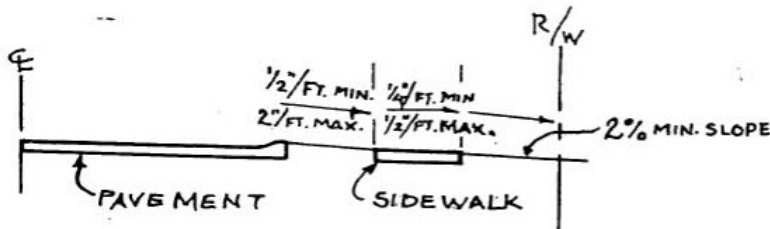
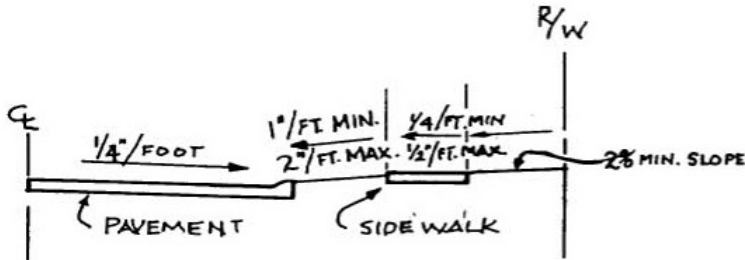
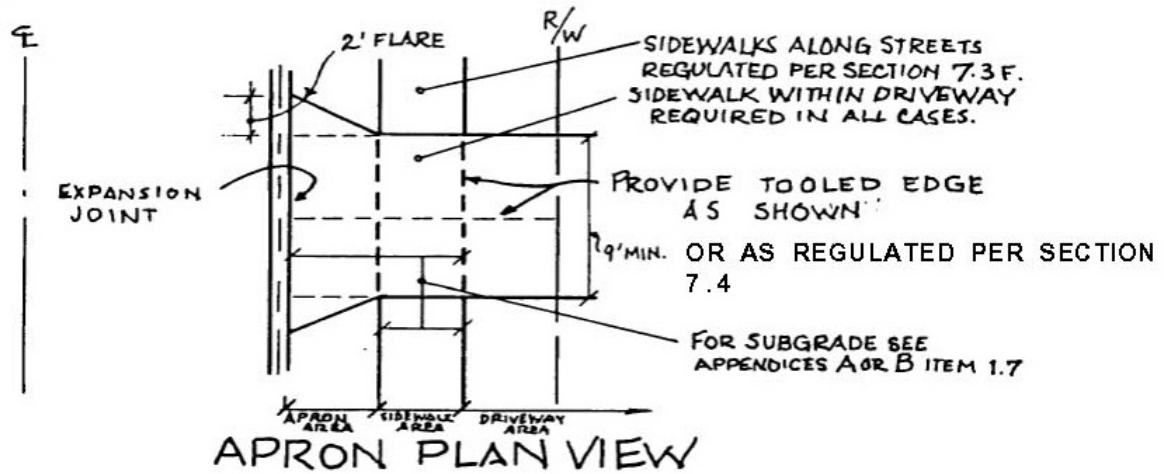

NOTE: SLOPES OUTSIDE OF STREET PAVEMENTS ARE MINIMUM STANDARD EXCEPT FOR AREAS IN TRANSITION FROM UPWARD TO DOWNWARD SLOPES ON SAME SIDE OF STREETS.

CATCH BASIN CURB INLETS

7380 Catch Basin Curb Inlet

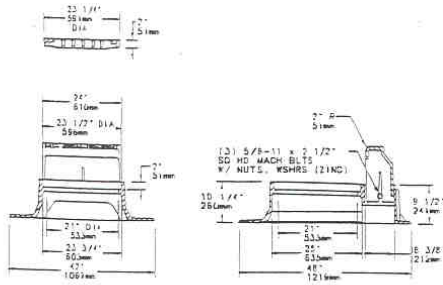

Heavy Duty
770 pounds (349kg) total weight
Approx. 160 sq. in. of opening

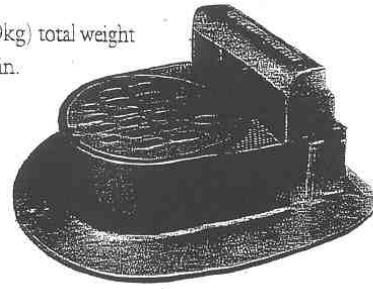

7390 Catch Basin Curb Inlet

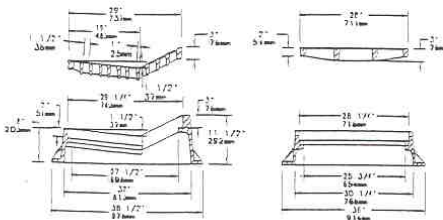

Heavy Duty
635 pounds (288kg) total weight
Approx. 360 sq. in. of opening

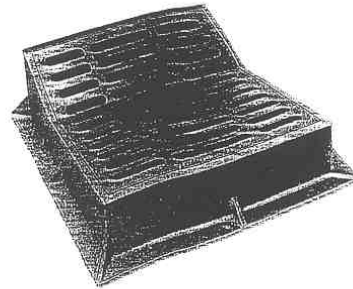

7391 Catch Basin Curb Inlet

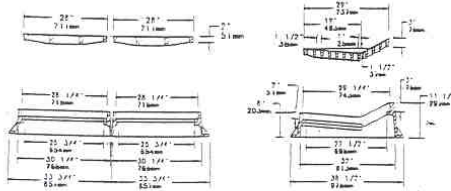

Heavy Duty
1180 pounds (535kg) total weight
Approx. 720 sq. in. of opening
Multiple Curb Inlet

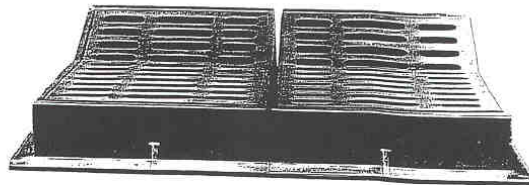

7395 Catch Basin Curb Inlet

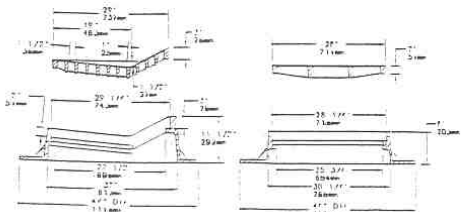

Heavy Duty
660 pounds (299kg) total weight
Approx. 360 sq. in. of opening

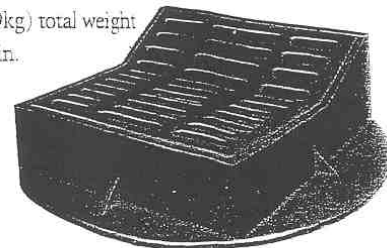

TYPICAL SECTION - SIDE DITCH DRAINAGE AT DRIVEWAY

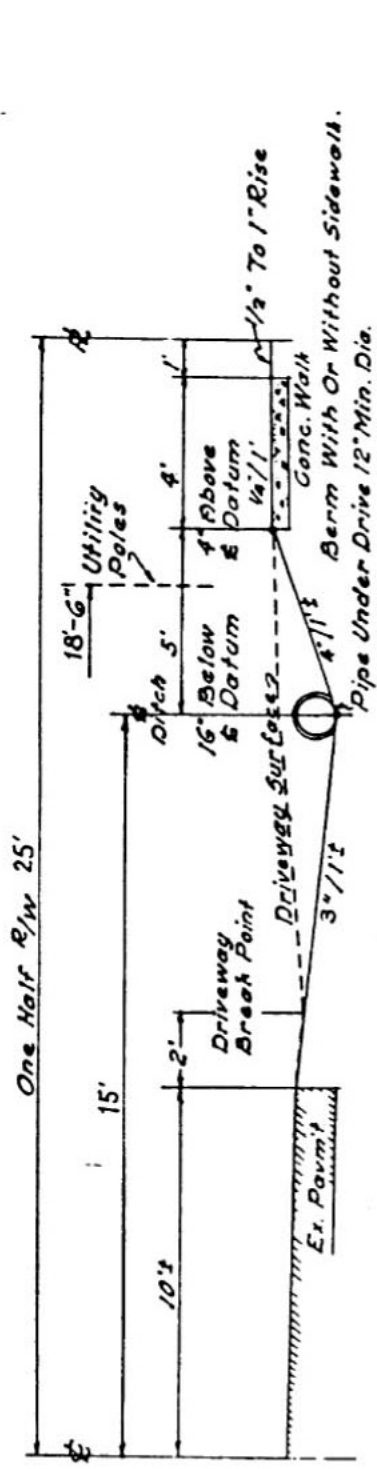

50 FOOT RIGHT OF WAYS

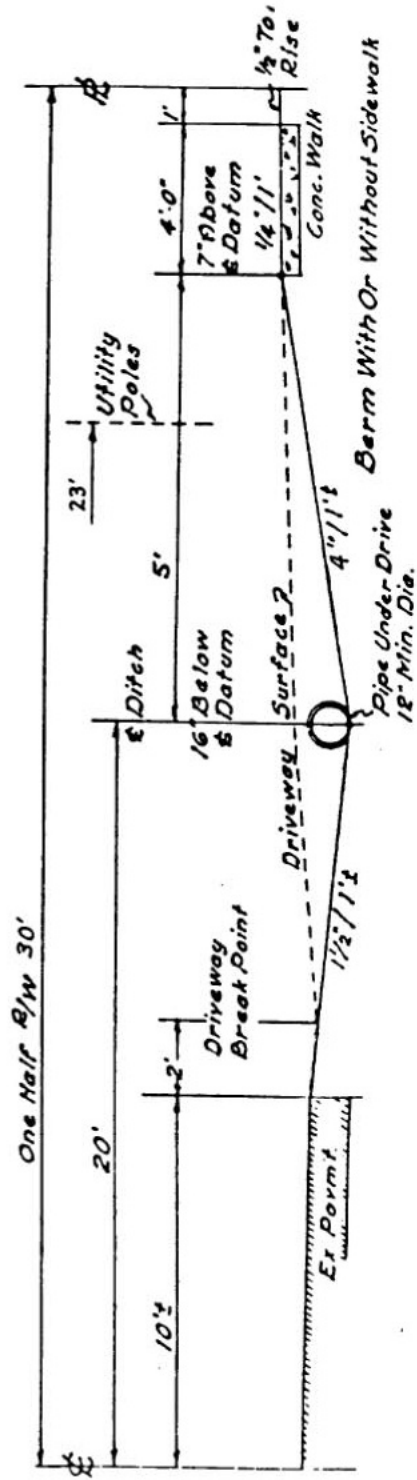

60 FOOT RIGHT OF WAYS

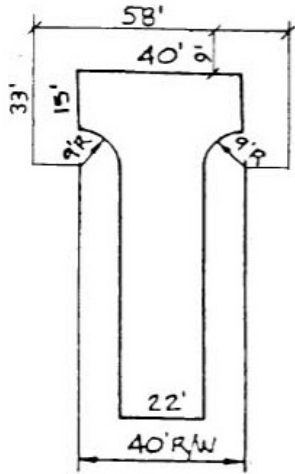

COURT
ALTERNATE T-TYPE

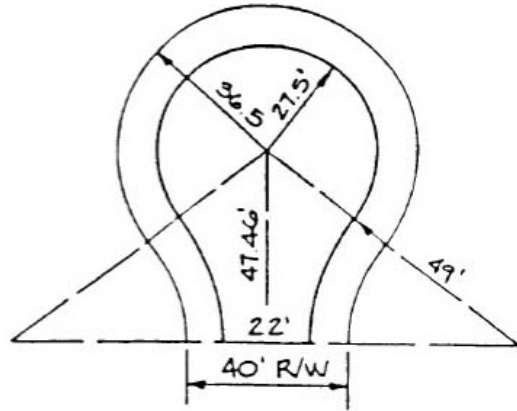

COURT

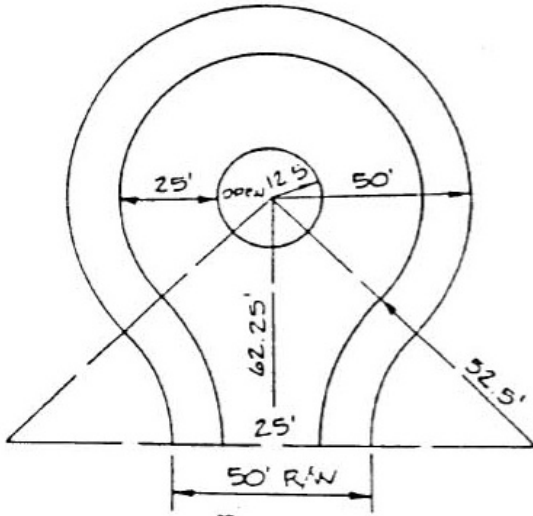

LOCAL

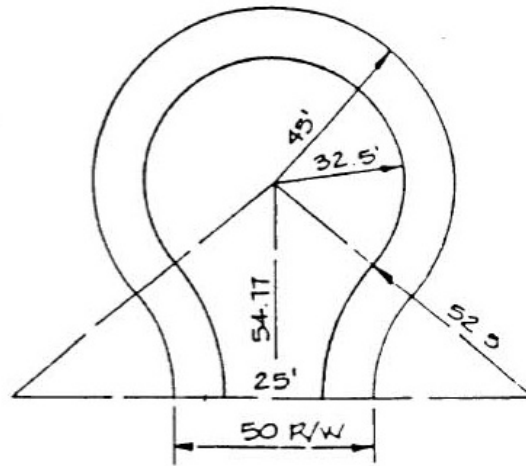

CUL-DE-SAC

TURN AROUND DETAILS
FOR DEADEND STREETS

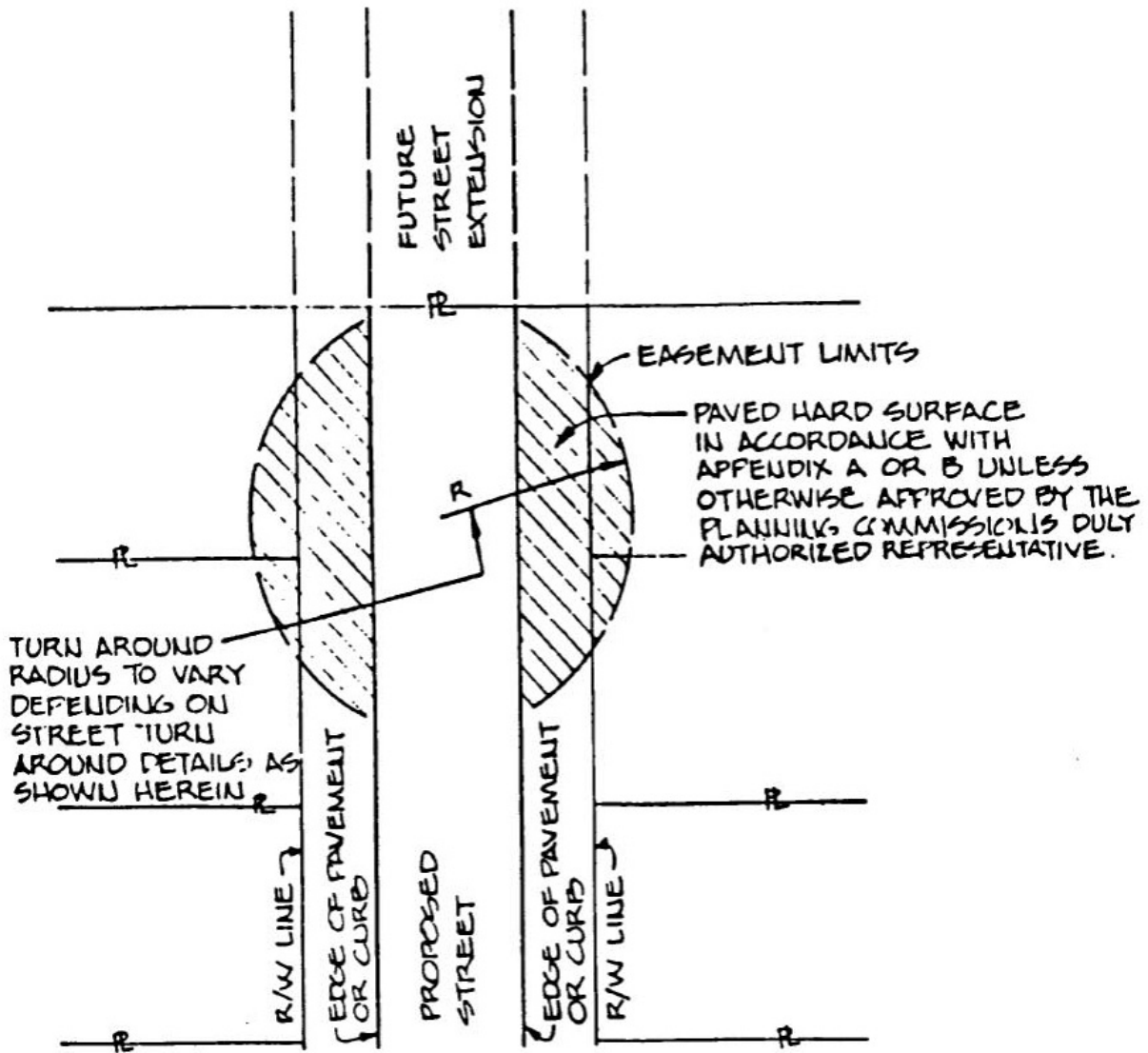

**DETAIL OF TEMPORARY TURNAROUND
FOR FUTURE STREET EXTENSION**

CURB AND GUTTER DETAILS

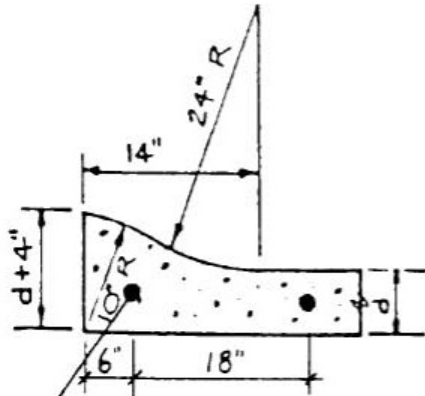

**INTEGRAL CURB
CONCRETE PAVEMENT**

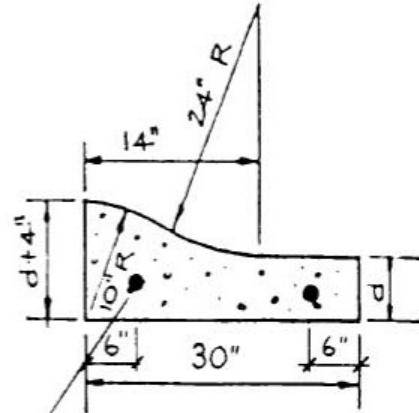

**CONCRETE CURB
ASPHALT PAVEMENT**

3/4" Φ DOWELS 18" LONG
18" O.C. TYPE I EXPANSION JOINT
WITH CAP.

3/4" Φ DOWELS 18" LONG 18" O.C.
TYPE 1 OR TYPE 3 TO COINCIDE WITH
EXPANSION OR CONSTRUCTION JOINTS

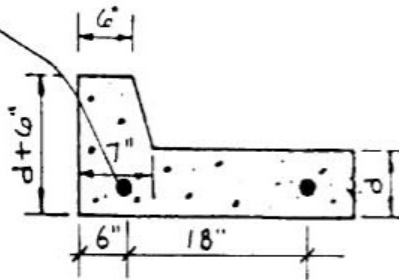

**INTEGRAL CURB
CONCRETE PAVEMENT**

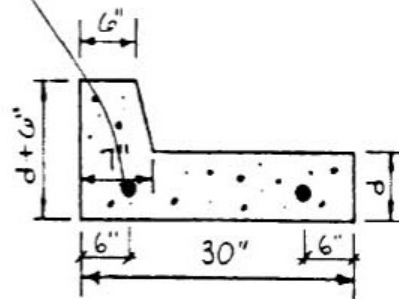

**CONCRETE CURB
ASPHALT PAVEMENT**

Note: Transverse expansion, contraction, and construction joints shall conform to these regulations

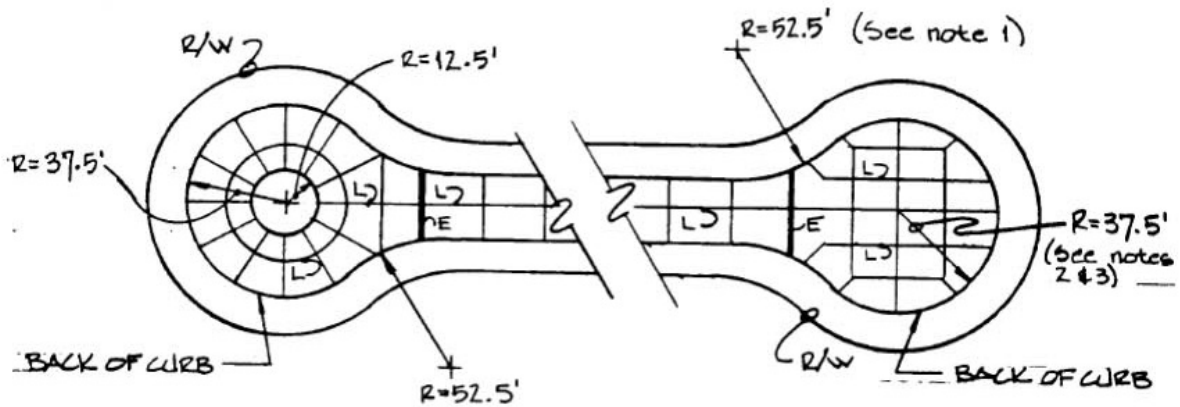

OPEN CENTER CUL DE SAC

FULLY PAVED CUL DE SAC

NOTES:

1. For 22' Courts $R=48'$
2. For 22' Courts $R=27.5'$
3. For 25' Cul De Sacs R may be reduced to 32.5 (see sheet C-6)

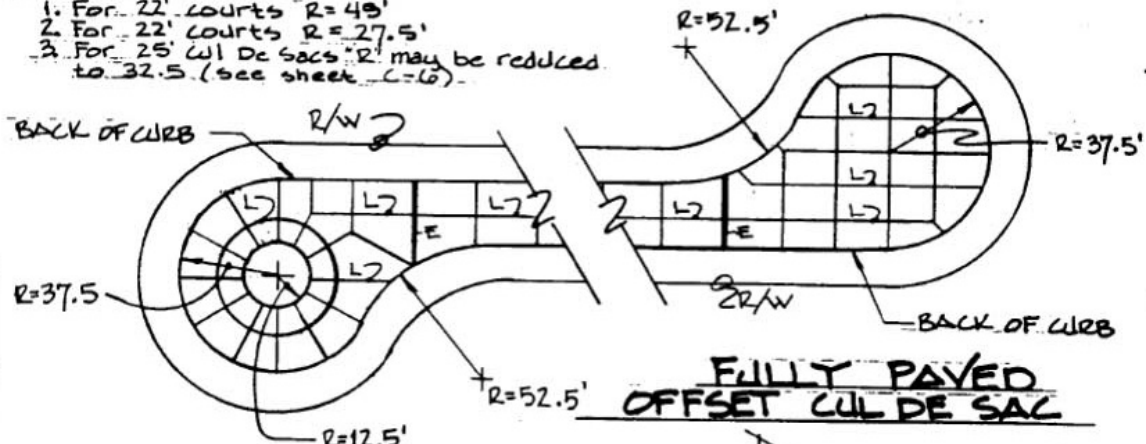

FULLY PAVED OFFSET CUL DE SAC

OPEN CENTER OFFSET CUL DE SAC

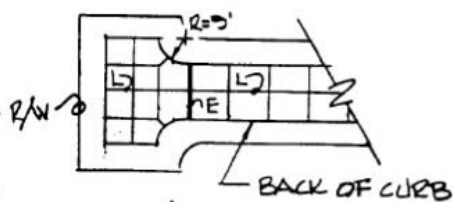

ALTERNATE T-TYPE (COURTS)

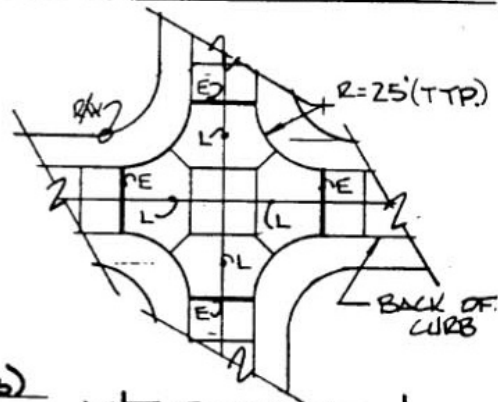

INTERSECTION

KEY:

- E - Expansion Joint
- L - Longitudinal Joint
- Unmarked joints are to be contraction joints

TYPICAL CONCRETE JOINTING PLAN

JOINT DETAILS

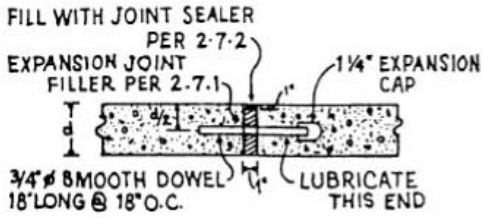

TYPE 1-Expansion Joint

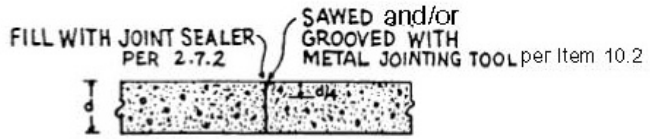

TYPE 2-Transverse Contraction Joint
(sawed or grooved joint)

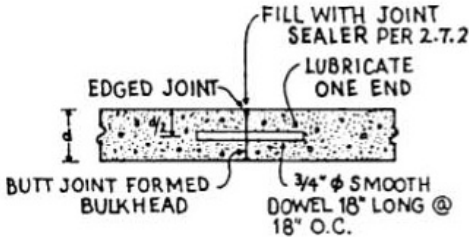

TYPE 3-Transverse Construction Joint
(planned-coincide with contraction joint)

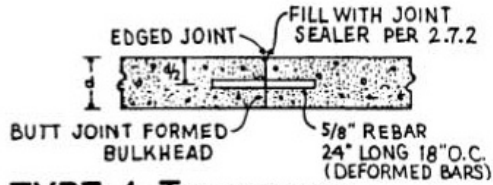

TYPE 4-Transverse Construction Joint
(emergency-not coincide with contraction joint)

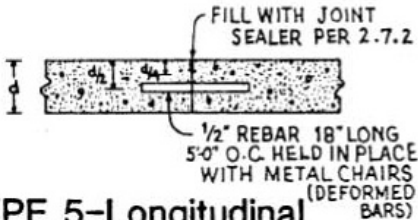

TYPE 5-Longitudinal Sawed Joint

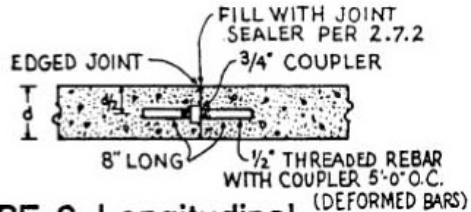

TYPE 6-Longitudinal Construction Joint
(threaded rebar)

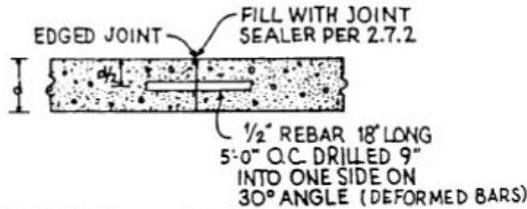

TYPE 7-Longitudinal Construction Joint Alt. (drilled) or per Item 10.4

MANHOLE DETAIL IN CONCRETE PAVEMENT

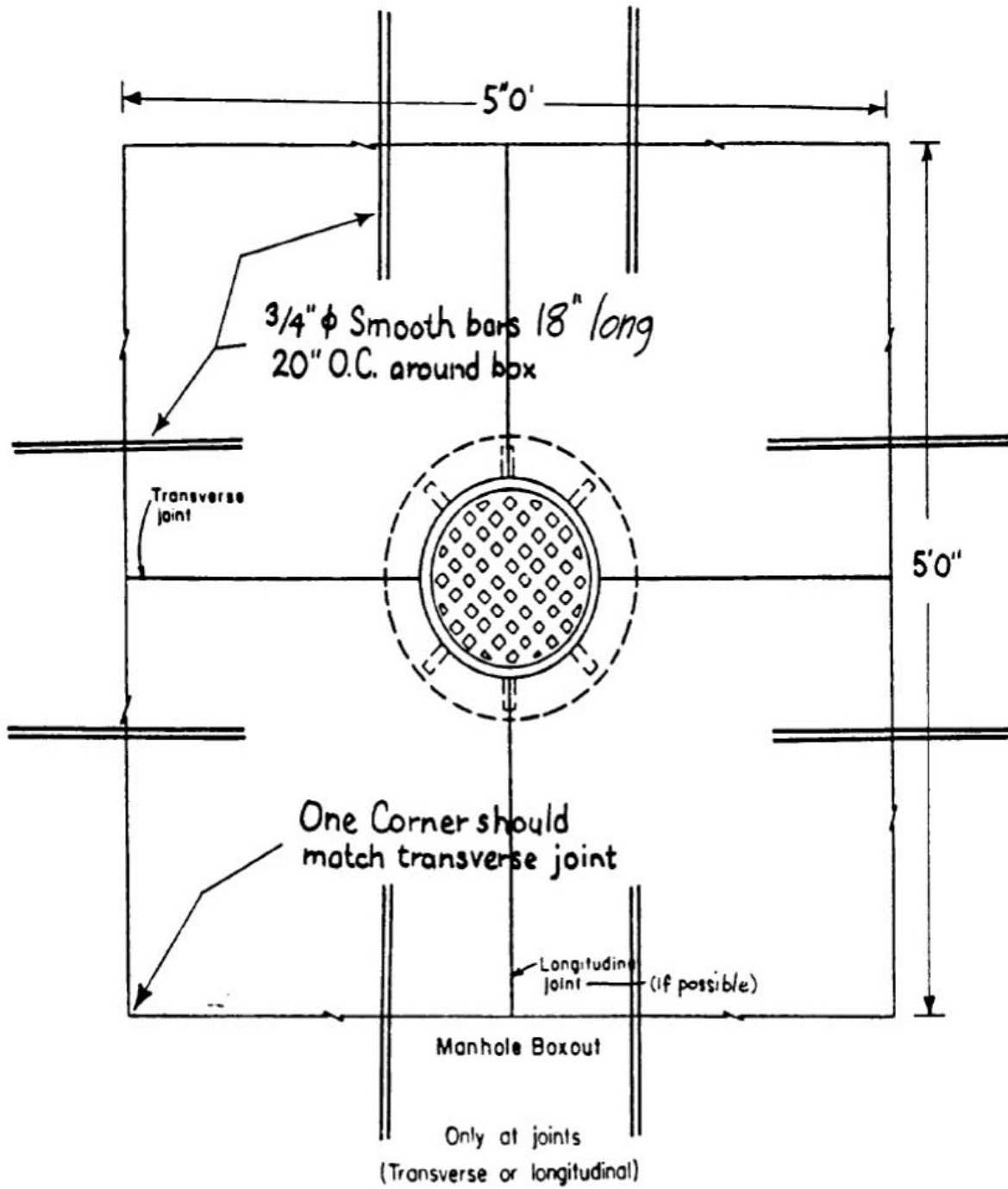

TYPICAL WATER MAIN AND FIRE HYDRANT ASSEMBLY LOCATION FOR ALL STREETS

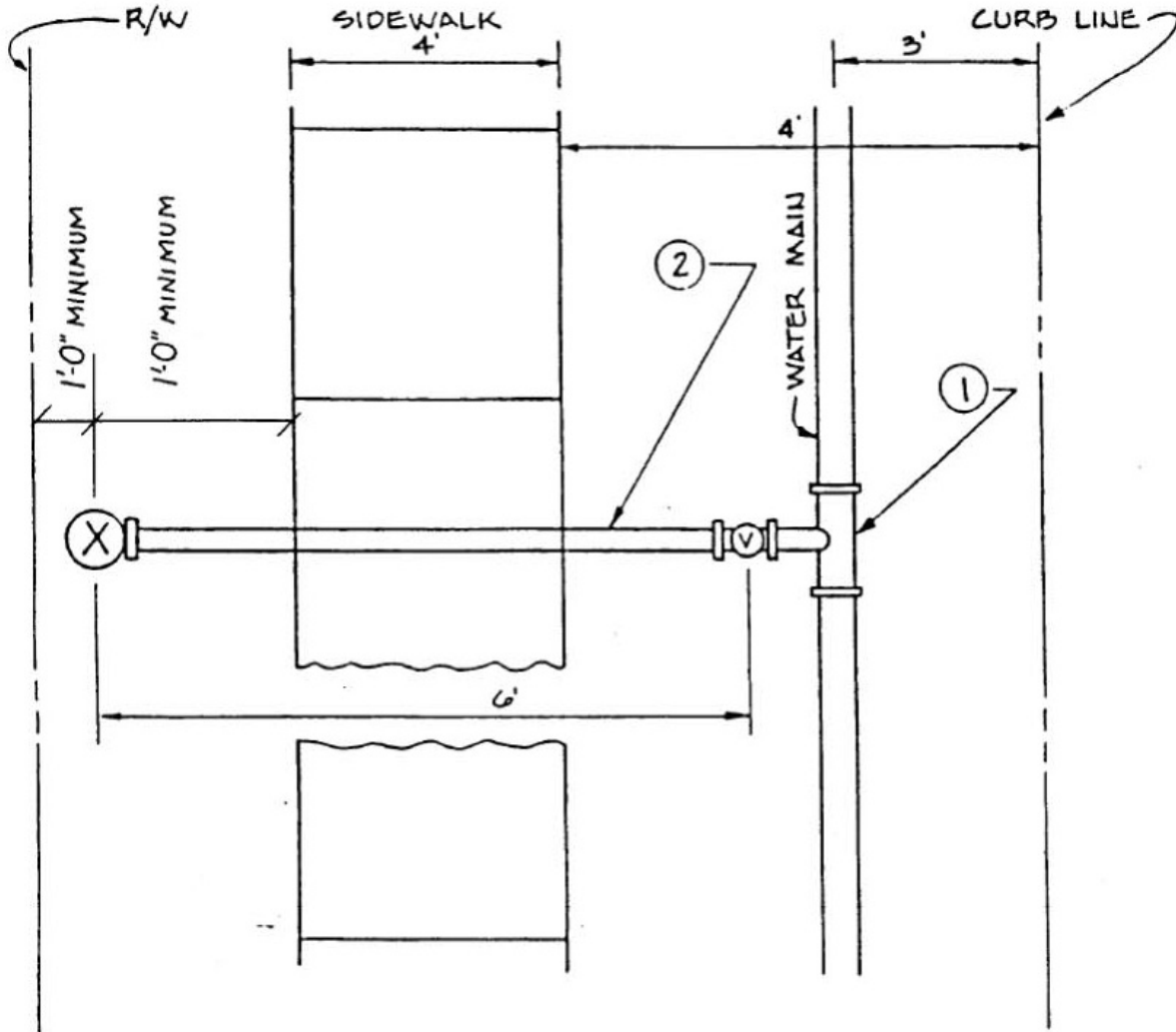

- ① - ANCHORING TEE - CLOW PART NO. F-1217
OR APPROVED EQUAL
- ② - HYDRANT ADAPTER - WILL BE SOLID X SWIVEL
CLOW PART NO. F-1211MS
OR APPROVED EQUAL

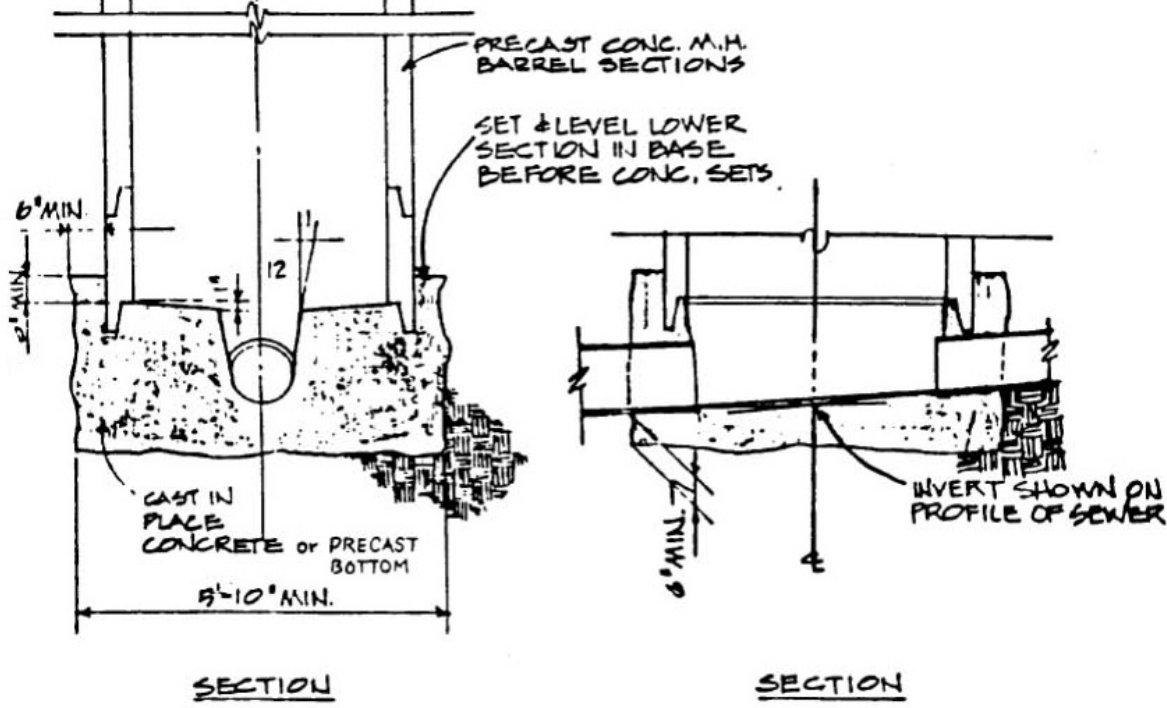
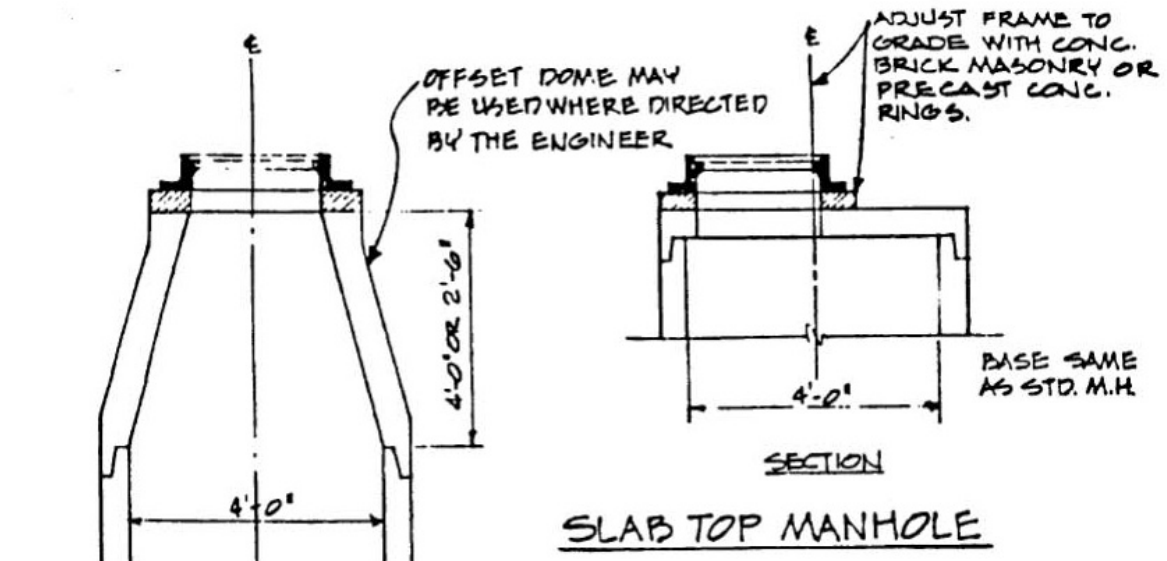

STANDARD MANHOLE

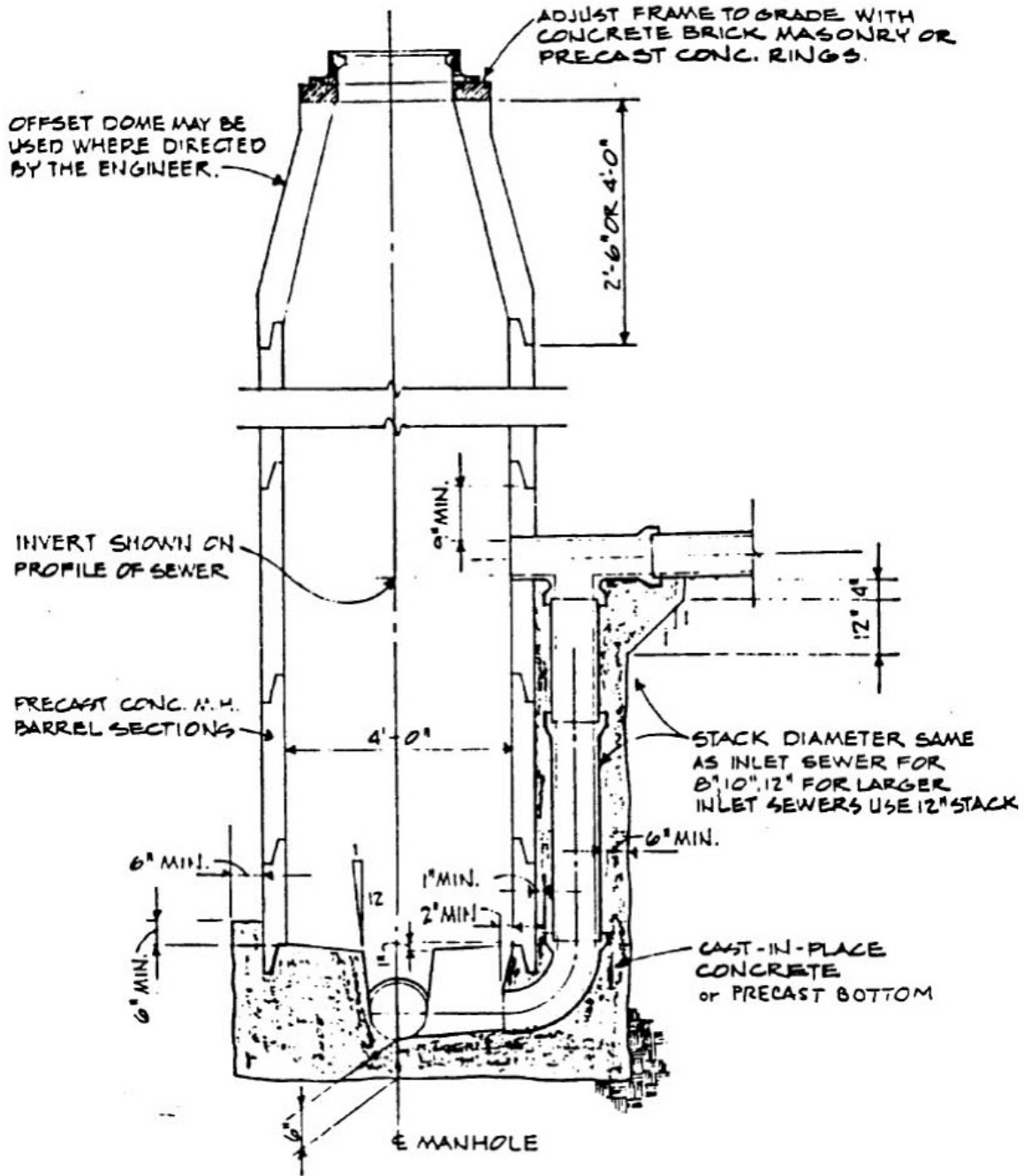

SECTION

STANDARD DROP MANHOLE

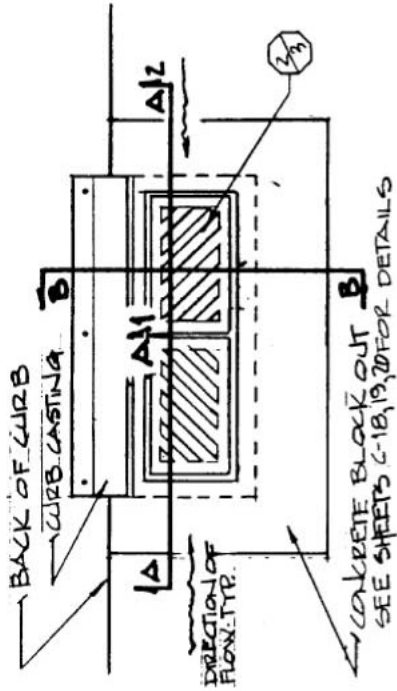

PLAN OF CATCH BASIN

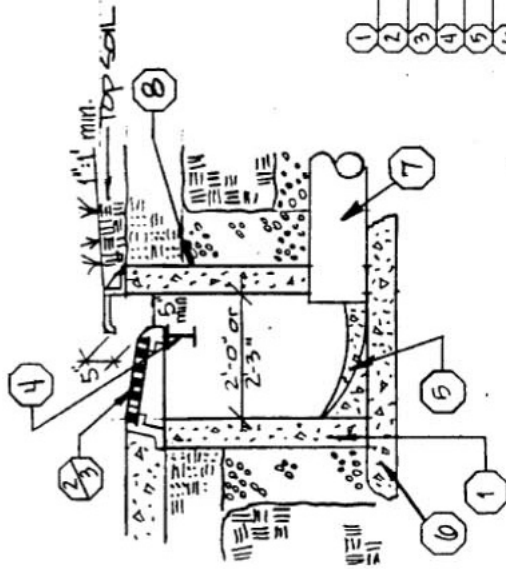

SECTION B-B

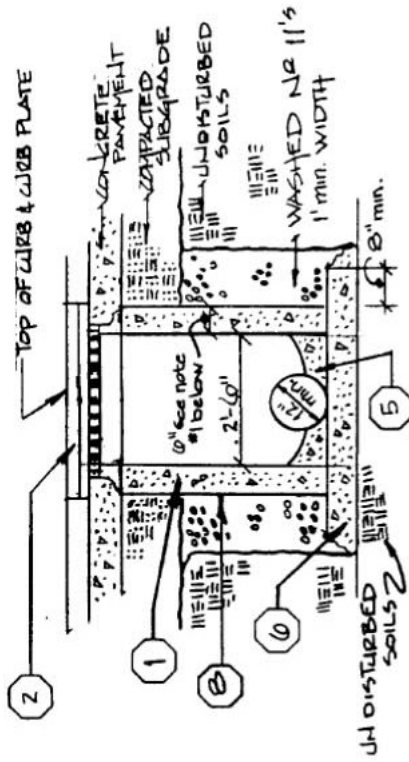

SECTION A-A-1

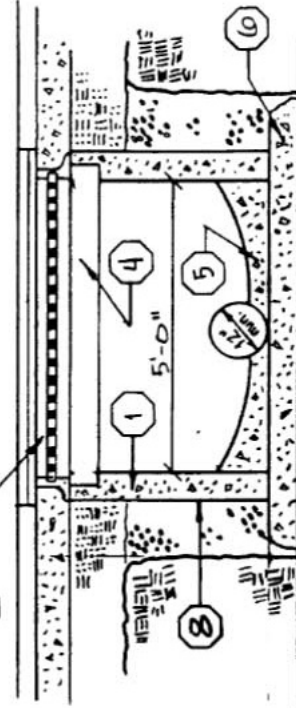

SECTION A-A-2

- 1 CONCRETE BLOCK OR SLAB BLOCK MAY BE USED IN PLACE OF PRECAST OR CURB-PLATE CONCRETE. SIDEWALLS SHALL BE 8\"/>
- 2 SIDEWALL SHALL BE 8\"/>
- 3 FRAME, GRATE AND CURB PLATE - HEIGHT: 2'-3\"/>
- 4 POSSIBLE INLET: 1. FRAME, GRATE AND CURB PLATE - HEIGHT: 2'-3\"/>
- 5 5'-0\"/>
- 6 4\"/>
- 7 10\"/>
- 8 12\"/>
- 9 LEFT REVERSE - 8\"/>

CATCH BASIN - DETAILS

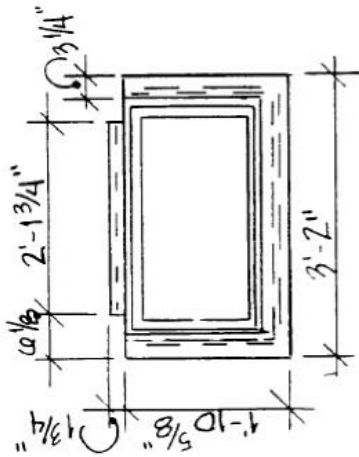

PLAN

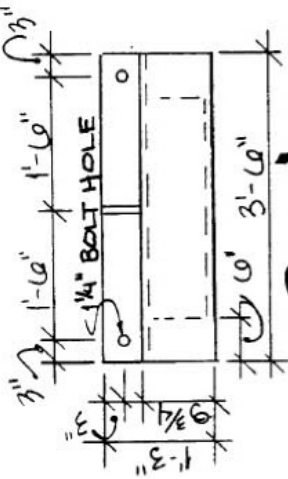

PLAN

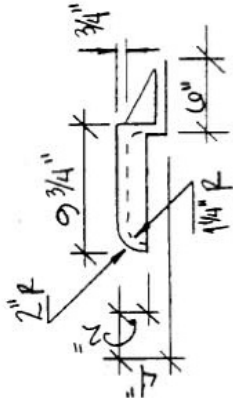

SIDE

CURB PLATE

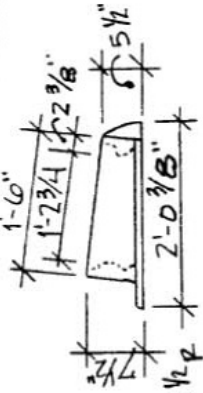

SIDE VIEW FRAME

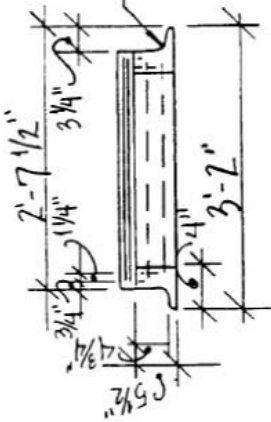

BACK VIEW

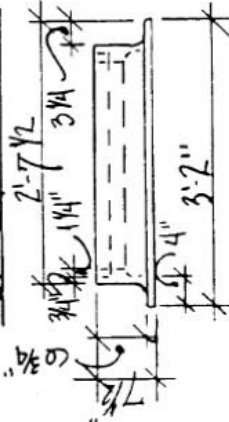

FRONT VIEW FRAME

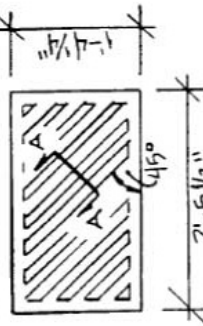

SECTION A-A

SECTION A-A

GRATE

- GRATE TYPE SHALL BE AS SHOWN IN THE PLAN VIEW AND SHALL BE PLACED SO THE DIAGONAL BAR'S DIRECT THE DRAINAGE FLOW TOWARD THE CURB (MUST SPECIFY DL OR DR)
- CASTING DESIGN'S SHALL BE ESSENTIALLY THE SAME AND EQUALLY AS STRONG AS THOSE SHOWN HEREON OR INCLUDED WITH IN SHEET C-17 MINIMUM TOTAL WEIGHTS: SINGLE INLET (NEENAH R-3288-EZ) 1325 LBS. DOUBLE INLET (NEENAH R-3288-EZ) 1325 LBS.
- BEARING AREAS OF FRAME AND GRATE SHALL BE SO FITTED AND FINISHED, WITHOUT PROJECTIONS, AS TO PROVIDE A FIRM AND EVEN SEAT FOR ALL PORTIONS OF THE GRATE IN THE FRAME WITHOUT ROCKING
- CURB PLATE SHALL BE SECURELY FASTENED WITH 3/4 INCH STAINLESS STEEL BOLTS

CB CASTINGS DETAILS - SINGLE

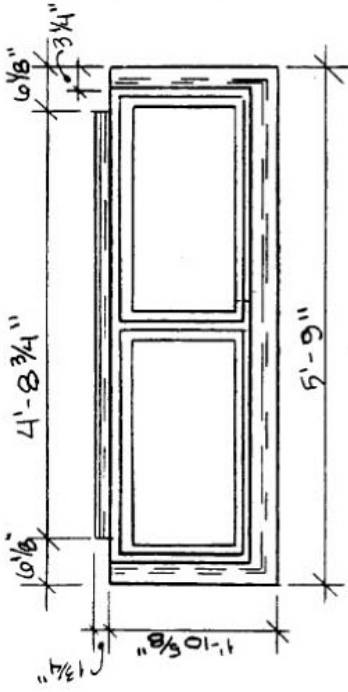

PLAN - DOUBLE

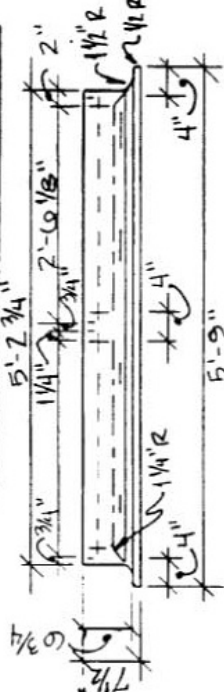

FRAME (FRONT VIEW)

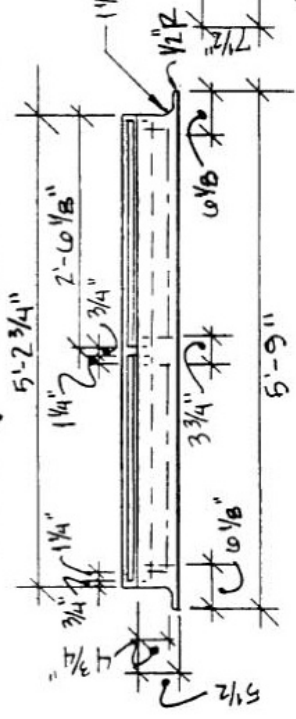

FRAME (BACK VIEW)

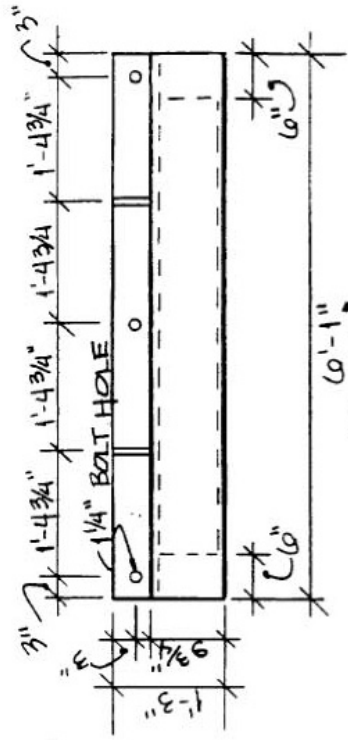

PLAN

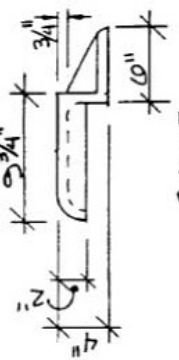

PIPE

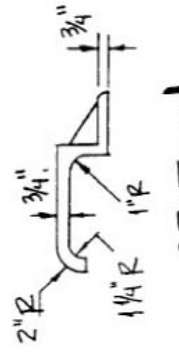

SECTION

CURB PLATE

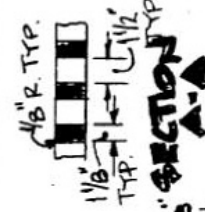

SECTION A-A

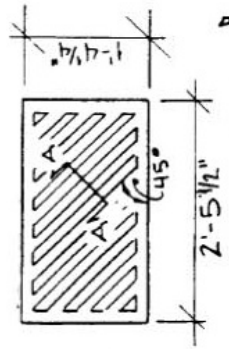

GRATE PLAN

NOTE: CASTINGS ILLUSTRATED ON THIS SHEET SHALL CONFORM TO THE SPECIFICATIONS SET FORTH ON SHEET C-10
CB CASTINGS DETAILS - DOUBLE

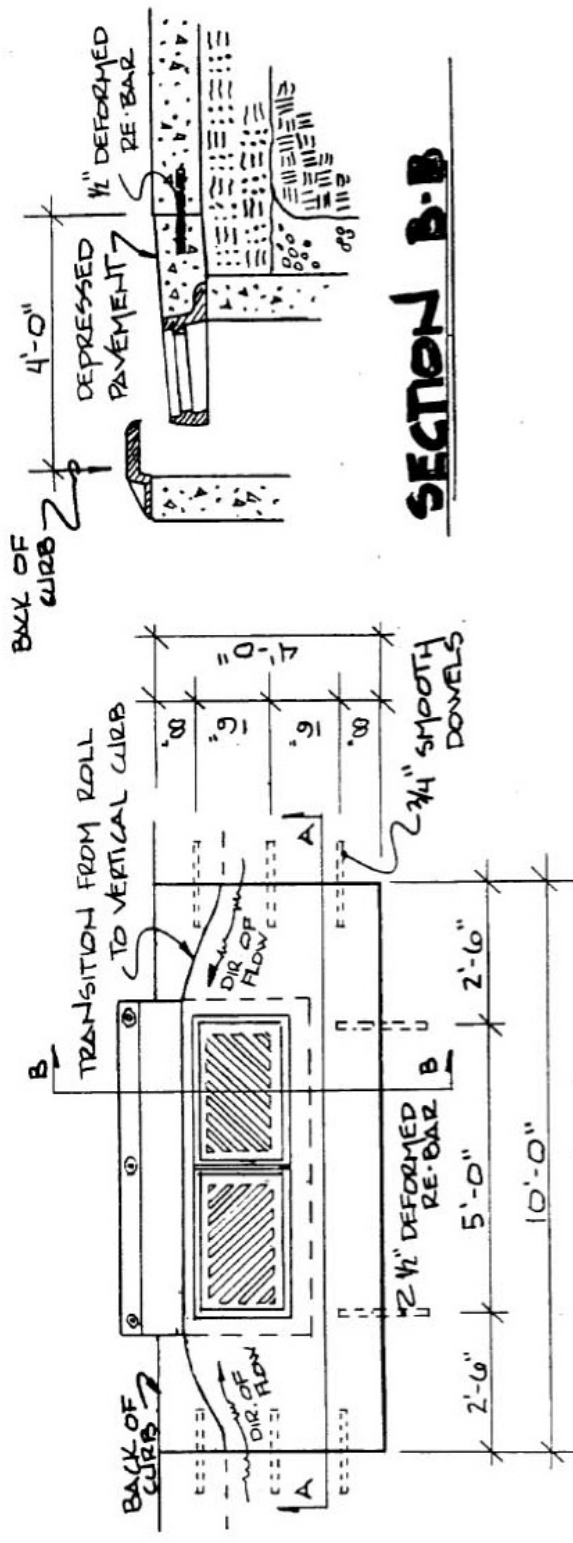

PLAN VIEW

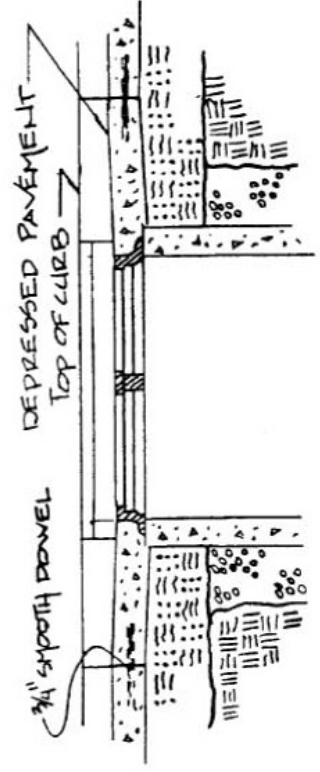

SECTION A-A

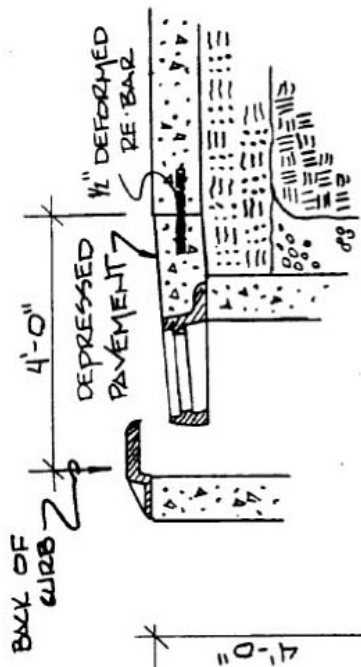

SECTION B-B

- BLOCKOUTS SHALL BE PAVED WITH 4000 PSI AIR ENTRAINED PORTLAND CEMENT CONCRETE
- BLOCKOUTS FOR SINGLE INLET CATCH BASINS SHALL BEAR THE SAME DIMENSIONS AS THE DOUBLE INLET CATCH BASIN
- 3/4" x 18" DOWELS ARE REQUIRED FOR CONCRETE PAVEMENT OR GUTTER BLOCKOUT - SEE SHEET C-10 FOR DOWEL DETAILS.
- TWO 1/2" x 18" PIECES OF DEFORMED REBAR ARE REQUIRED ALONG BUILT JOINT OF ISOLATION AREA
- PAVEMENT THICKNESS SHALL CONFORM TO THE RELATED STREET CLASSIFICATIONS PER SECTION 7. TABLE 3 OF THESE REGULATIONS

RIGID PAVEMENT BLOCKOUT DETAIL

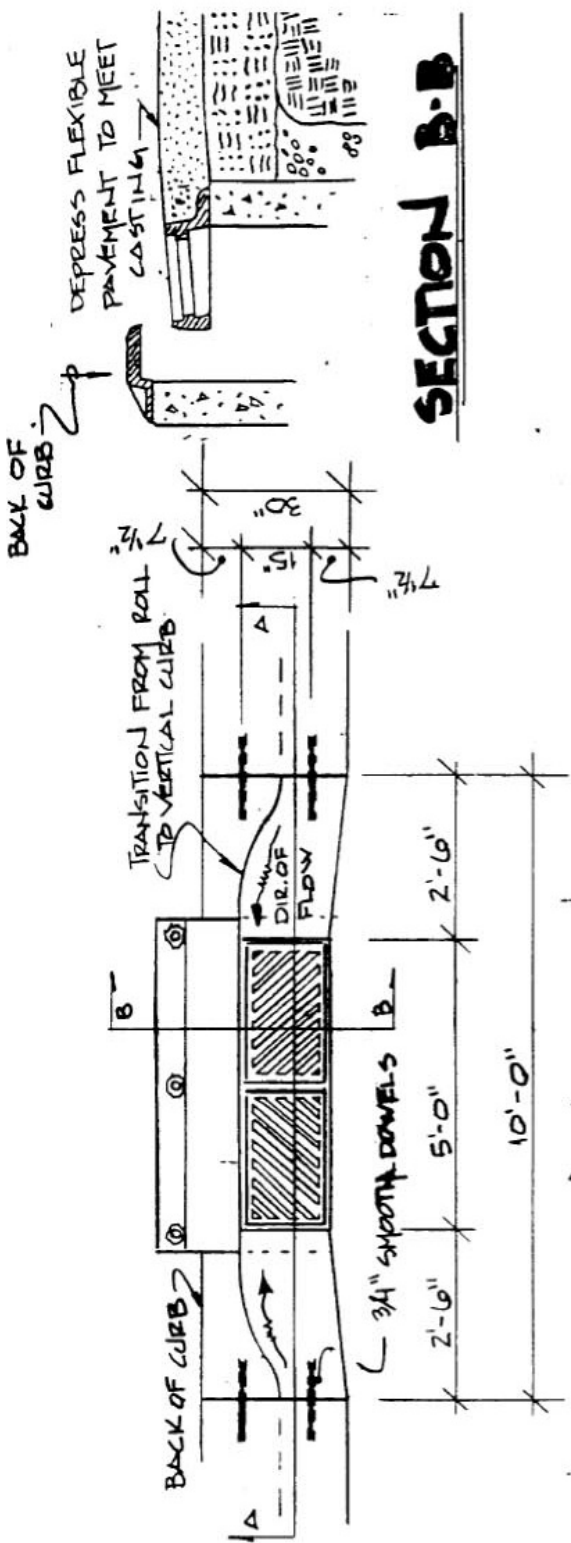

SECTION B-B

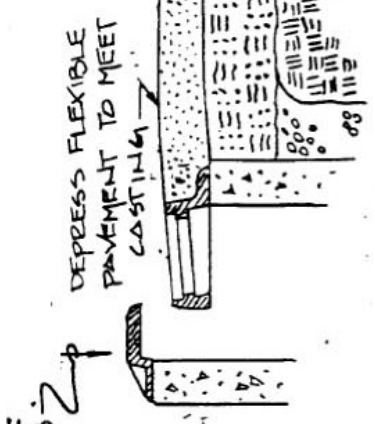

PLAN VIEW

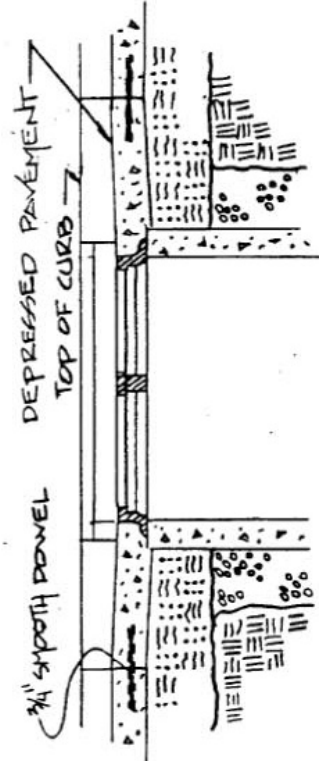

SECTION A-A

- BLOCKOUTS SHALL BE PAVED WITH 4000 PSI AIR ENTRAINED PORTLAND CEMENT CONCRETE.
- BLOCKOUTS FOR SINGLE INLET CATCH BASINS SHALL BEAR THE SAME DIMENSIONS AS THE DOUBLE INLET CATCH BASIN.
- 3/4" X 18" DOWELS ARE REQUIRED FOR CONCRETE PAVEMENT OR GUTTER BLOCKOUT - SEE SHEET C-10 FOR DOWEL DETAILS.
- PAVEMENT THICKNESS SHALL CONFORM TO THE RELATED STREET CLASSIFICATIONS PER SECTION 7. TABLE 3 OF THESE REGULATIONS.

ALTERNATIVE - A
FLEXIBLE PAVEMENT BLOCKOUT DETAIL

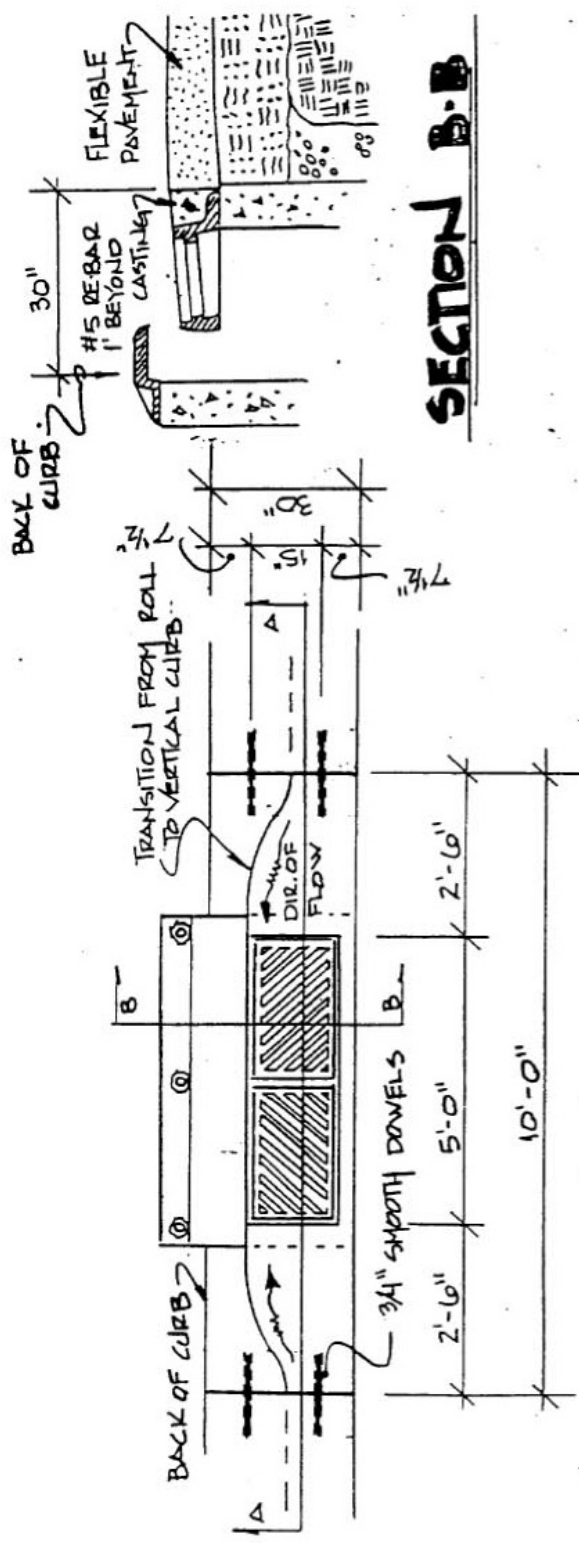

SECTION B-B

PLAN VIEW

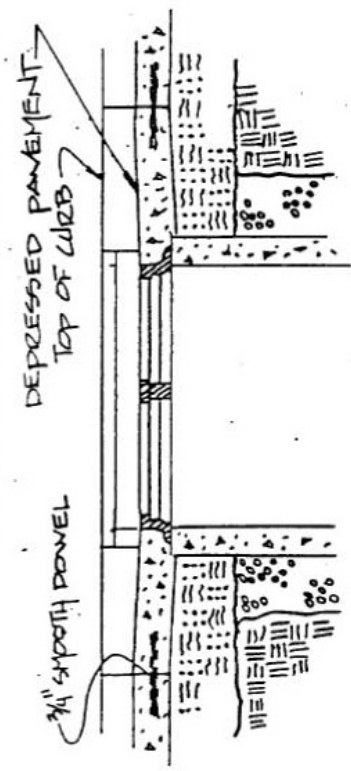

SECTION A-A

**ALTERNATIVE - B
FLEXIBLE PAVEMENT BLOCKOUT DETAIL**

- BLOCKOUTS SHALL BE PAVED WITH 4000 PSI AIR ENTRAINED PORTLAND CEMENT CONCRETE.
- BLOCKOUTS FOR SINGLE INLET CATCH BASINS SHALL BEAR THE SAME DIMENSIONS AS THE DOUBLE INLET CATCH BASIN.
- 3/4" X 18" DOWELS ARE REQUIRED FOR CONCRETE PAVEMENT OR GUTTER BLOCKOUT - SEE SHEET C-10 FOR DOWEL DETAILS.
- PAVEMENT THICKNESS SHALL CONFORM TO THE RELATED STREET CLASSIFICATIONS PER SECTION 7-TABLE 3 OF THESE REGULATIONS.

Capacity of surface openings shall be minimum 2 times x Section area of pipe discharge

Side window(s) maximum 6" opening

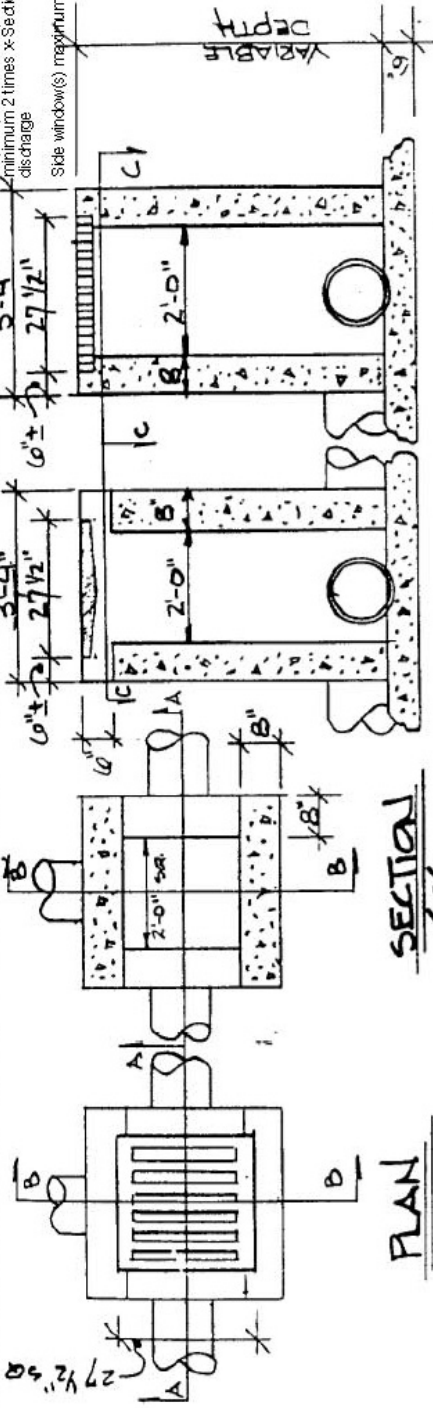

SECTION B-B

SECTION A-A

SECTION C-C

YARD DRAIN: 2x2-W

GRATE AND FRAME SHALL BE ESSENTIALLY THE SAME AND EQUALLY AS STROKES AS SHOWN HEREON (NEEDS 2-41871 & 2-41859-C OR APPROVED EQUAL)

2x2-W SIDE INLETS TO BE PLACED 4'-0" INCHES BELOW NORMAL ELEVATION OF DITCH FLOW LINE RETURNING TO NORMAL 10 FEET EACH SIDE OF YARD DRAIN

2x2-W MAY HAVE SIDE INLET ON UPSTREAM SIDE ONLY WHERE DITCH HAS A CONTINUOUS DOWN GRADE PAST THE YARD DRAIN

2x25 GRATE ELEVATION SHALL BE PLACED 4'-0" INCHES BELOW NORMAL FLOW LINE RETURNING 10 FEET EACH SIDE OF YARD DRAIN

NOTES 1, 5, 6, 7 AND 8 OF CATCH BASIN DETAILS SHEET C-15 SHALL APPLY TO DETAILS SHOWN HEREON

Maximum Dimension of any Surface Inlet/Window opening shall be such that a sphere with a diameter of 6 inches cannot pass through any opening

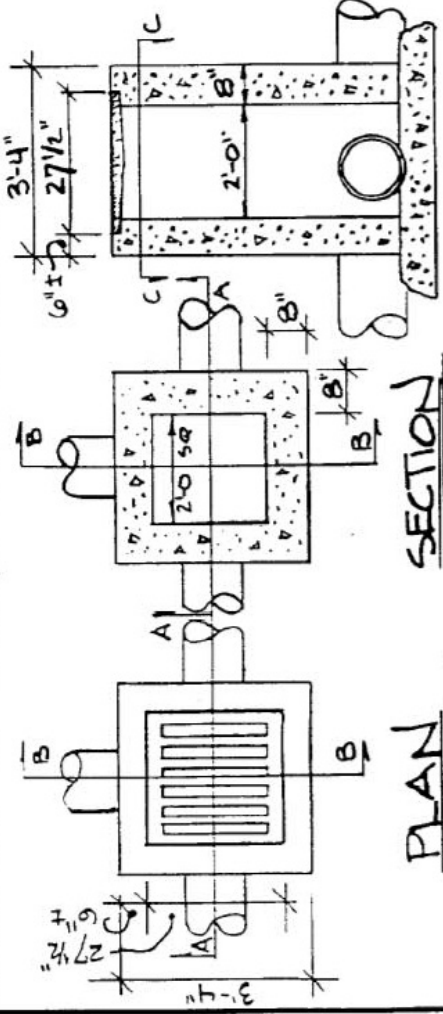

SECTION A-A

SECTION C-C

NOTE: SECTION B-B SAME AS ABOVE

YARD DRAIN: 2x2-S

YARD DRAIN - DETAILS

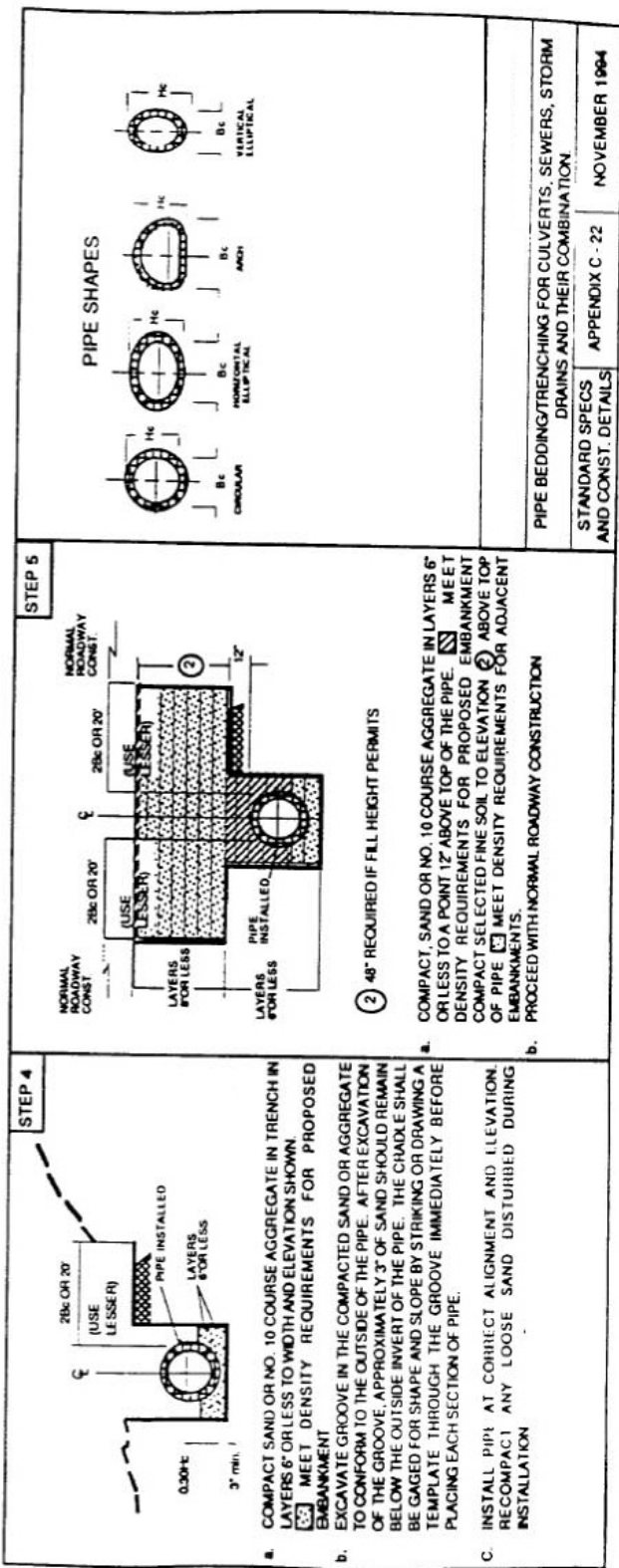
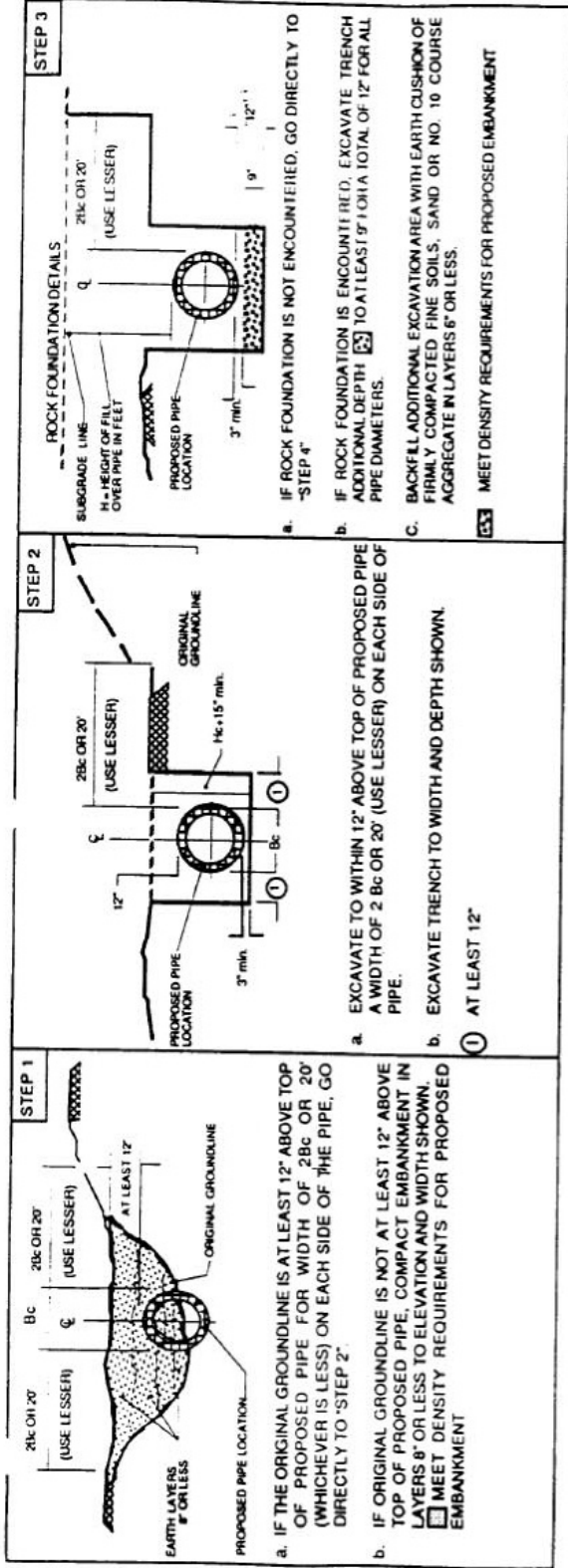

HEADWALL DIMENSIONS AND QUANTITIES

HEADWALL TYPE	DIAMETER OF PIPE	HEADWALL DIMENSIONS										CUBIC YARDS CONCRETE FOR ONE HEADWALL	
		A	B	C	D	E	F	G	H	J	Earth	Rock	
STANDARD	12"	1'-8"	1'-2"	4'-0"	2'-6"	-	-	-	-	6'-0"	1.05	0.87	
	15"	1'-8"	1'-2 1/2"	4'-3"	2'-9"	-	-	-	-	6'-9"	1.25	1.03	
	18"	1'-9"	1'-3"	4'-6"	3'-0"	-	-	-	-	7'-6"	1.48	1.23	
	21"	1'-9 1/2"	1'-3 1/2"	4'-9"	3'-3"	-	-	-	-	8'-3"	1.73	1.46	
	24"	1'-10"	1'-4"	5'-0"	3'-6"	-	-	-	-	9'-0"	1.99	1.69	
RAISE	27"	1'-10 1/2"	1'-4 1/2"	5'-3"	3'-9"	-	-	-	-	9'-9"	2.27	1.93	
	12"	1'-8"	1'-2"	4'-6"	3'-0"	-	-	-	7'-6"	1.45	1.23		
	18"	1'-8 1/2"	1'-2 1/2"	4'-9"	3'-3"	-	-	-	8'-3"	1.69	1.43		
	21"	1'-9"	1'-3"	5'-0"	3'-6"	-	-	-	9'-0"	1.96	1.67		
	24"	1'-9 1/2"	1'-3 1/2"	5'-3"	3'-9"	-	-	-	9'-9"	2.25	1.93		
STANDARD ELL	27"	1'-10"	1'-4"	5'-6"	4'-0"	-	-	-	10'-6"	2.54	2.19		
	12"	1'-8"	1'-2"	4'-0"	2'-6"	2'-0"	3'-8"	3'-0"	2'-6"	4'-8"	1.19	0.99	
	15"	1'-8 1/2"	1'-2 1/2"	4'-3"	2'-9"	2'-3"	3'-11 1/2"	3'-6"	2'-9"	5'-2 1/2"	1.42	1.19	
	18"	1'-9"	1'-3"	4'-6"	3'-0"	2'-6"	4'-3"	4'-6"	3'-0"	5'-9"	1.67	1.41	
	21"	1'-9 1/2"	1'-3 1/2"	4'-9"	3'-3"	2'-9"	4'-6 1/2"	4'-6"	3'-3"	6'-3 1/2"	1.93	1.63	
RAISE ELL	24"	1'-10"	1'-4"	5'-0"	3'-6"	3'-0"	4'-10"	5'-0"	3'-6"	6'-10"	2.22	1.89	
	27"	1'-10 1/2"	1'-4 1/2"	5'-3"	3'-9"	3'-3"	5'-1 1/2"	5'-6"	3'-9"	7'-4 1/2"	2.52	2.15	
	12"	1'-8"	1'-2"	4'-6"	3'-0"	2'-9"	4'-5"	3'-9"	3'-3"	5'-5"	1.62	1.37	
	15"	1'-8 1/2"	1'-2 1/2"	4'-9"	3'-3"	3'-0"	4'-8 1/2"	4'-3"	3'-6"	5'-11 1/2"	1.88	1.59	
	18"	1'-9"	1'-3"	5'-0"	3'-6"	3'-3"	5'-0"	4'-9"	3'-9"	6'-6"	2.16	1.85	
STANDARD ELL	21"	1'-9 1/2"	1'-3 1/2"	5'-3"	3'-9"	3'-6"	5'-3 1/2"	5'-3"	4'-0"	7'-0 1/2"	2.47	2.12	
	24"	1'-10"	1'-4"	5'-6"	4'-0"	3'-9"	5'-7"	5'-9"	4'-3"	7'-7"	2.79	2.41	
RAISE ELL	27"	1'-10 1/2"	1'-4 1/2"	5'-9"	4'-3"	4'-0"	5'-10 1/2"	6'-3"	4'-6"	8'-1 1/2"	3.14	2.72	

CONCRETE HEADWALL

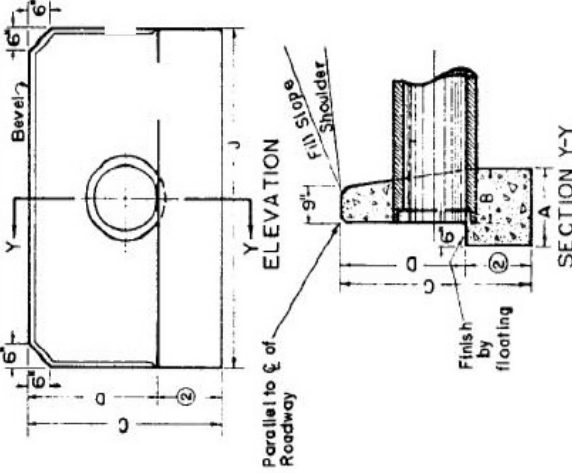

NOTES

- 1 Circular Pipe includes slightly elliptical concrete pipe with circular reinforcement.
- 2 Volume displaced by barrel of pipe has been computed using inside dimension of pipe.
- 3 The dimension and/or the angle of intersection between the walls may be varied on construction.

Volume based on values of 18" for earth, 12" for rock.

Straight face Headwalls for 24 inch pipe and smaller used as inlets are prohibited

Safety Guards or Railings may be required

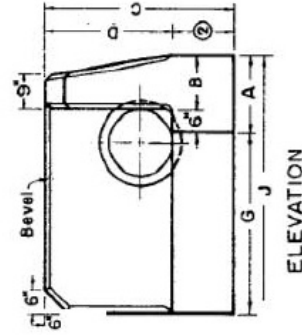

CONCRETE ELL HEADWALL

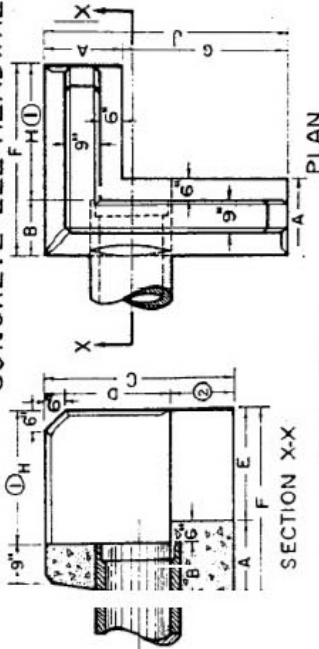

KENTUCKY
BUREAU OF HIGHWAYS
CONCRETE HEADWALLS
FOR
12"-27"
CIRCULAR PIPE CULVERTS
STANDARD DRAWING NO. R0H-005
REVISED 1-15-37
APPROVED BY [Signature]

Safety Guard or Railing required for inlets and outlets having vertical drop 4'-0" or greater.
 Minimum 42" high 4" maximum opening solid material nonladder type.

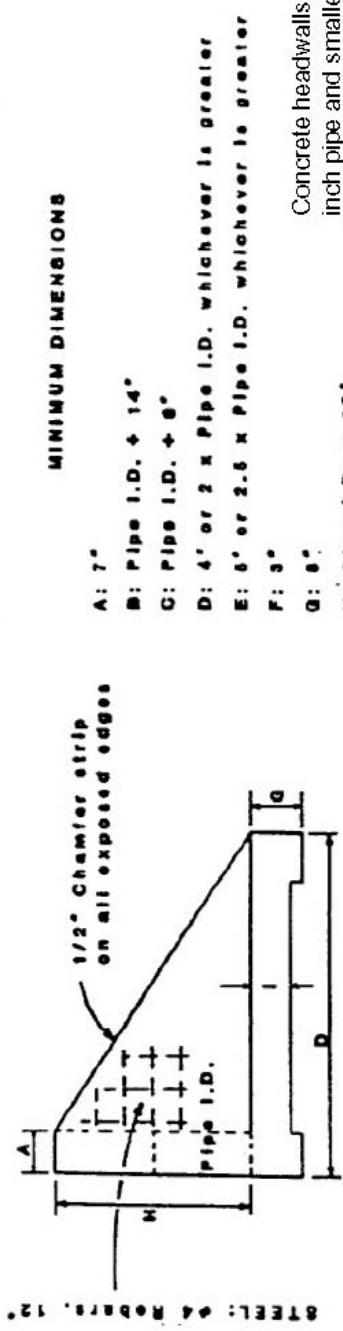
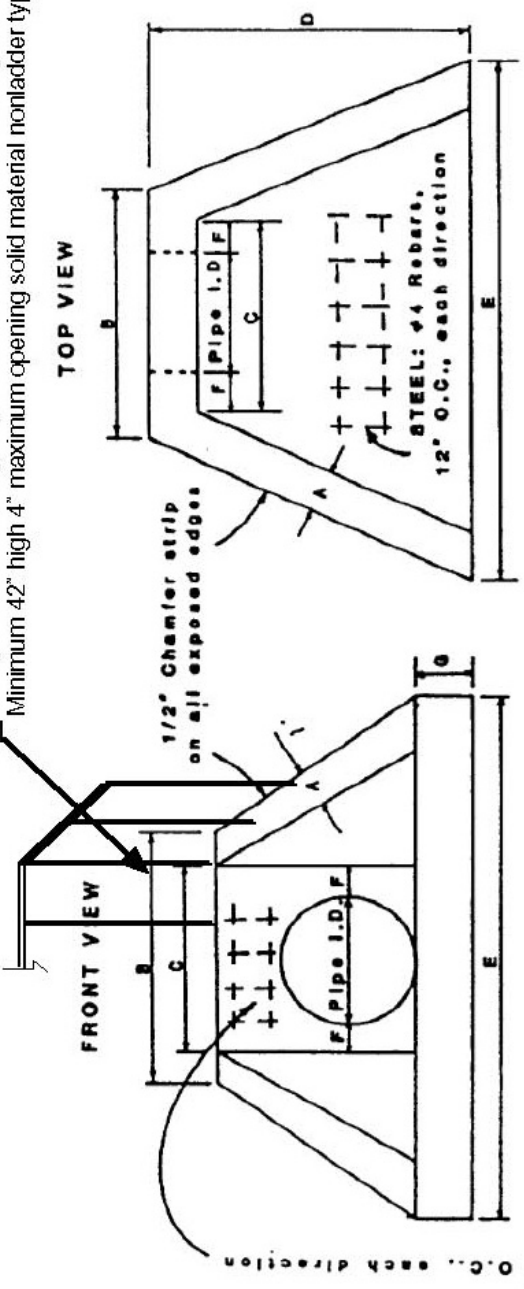

MINIMUM DIMENSIONS

- A: 7"
- B: Pipe I.D. + 14"
- C: Pipe I.D. + 6"
- D: 4' or 2 x Pipe I.D., whichever is greater
- E: 6' or 2.5 x Pipe I.D., whichever is greater
- F: 3"
- G: 6"
- H: Pipe I.D. + 12"
- I: 6"

Concrete headwalls with sidewalls for 24 inch pipe and smaller used as inlets require enclosure grates, per Appendix D of these regulations. Capacity of inlet shall be two (2) times pipe discharge diameter at same maximum headwater depth.

HEADWALL DETAIL for 12" thru 36" I.D. Pipe

ENCLOSURE GRATE FOR INLET HEADWALL 24" DIAMETER PIPE OR LESS

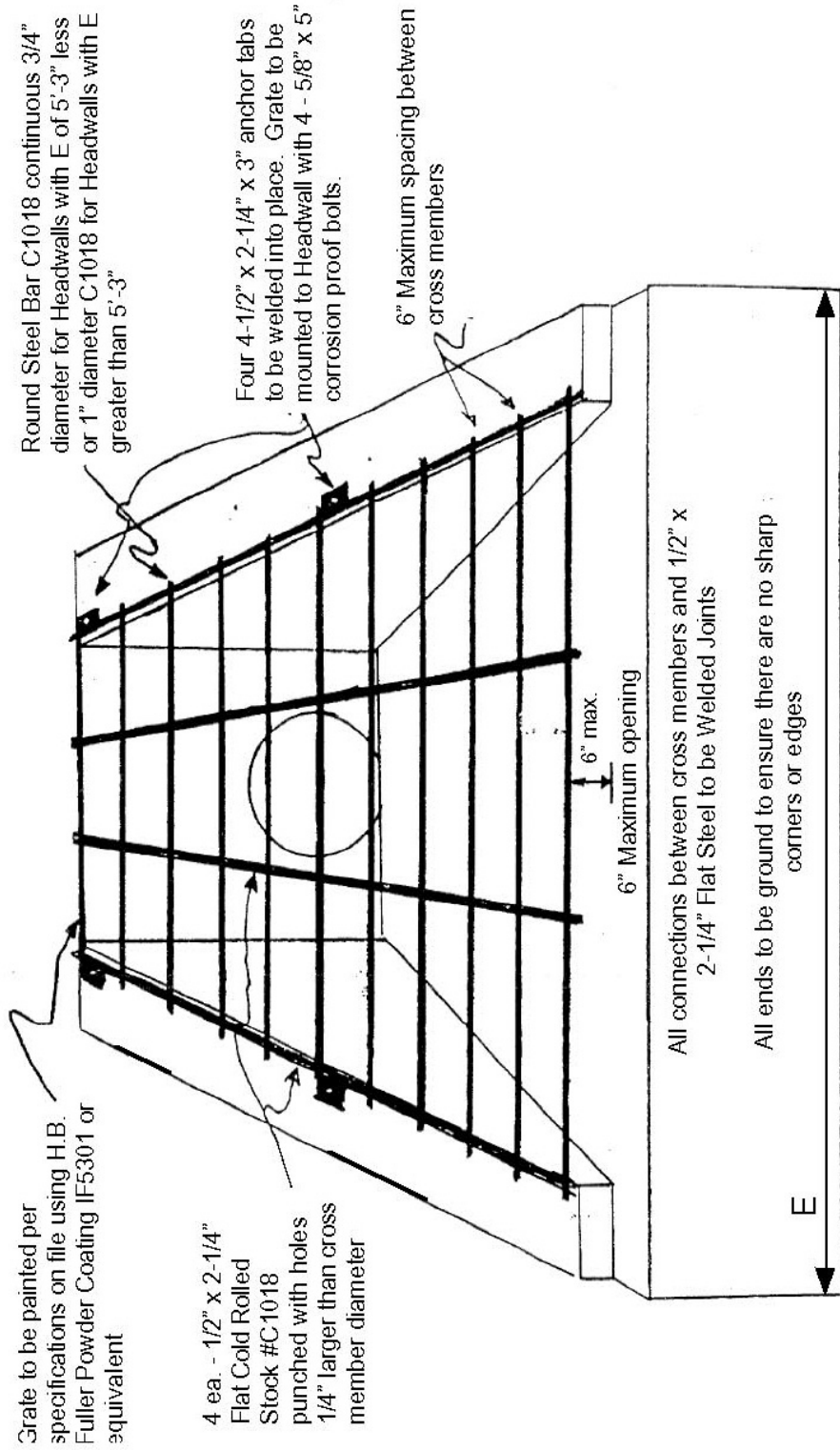

PLAN VIEW OF STRUCTURE LOCATIONS

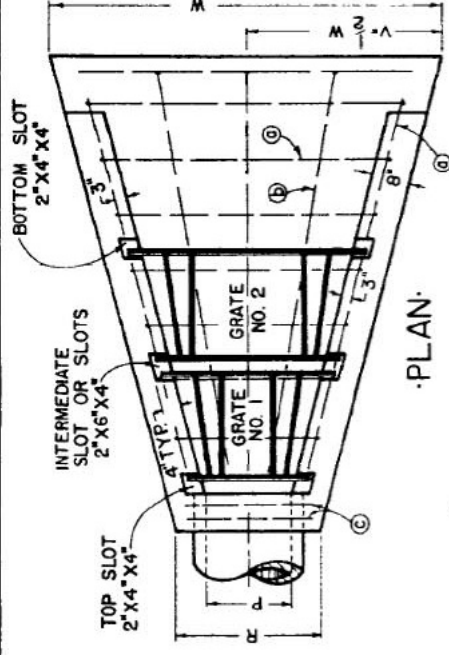
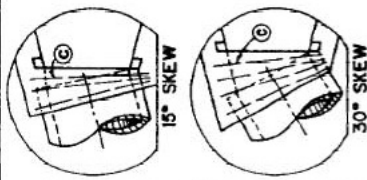
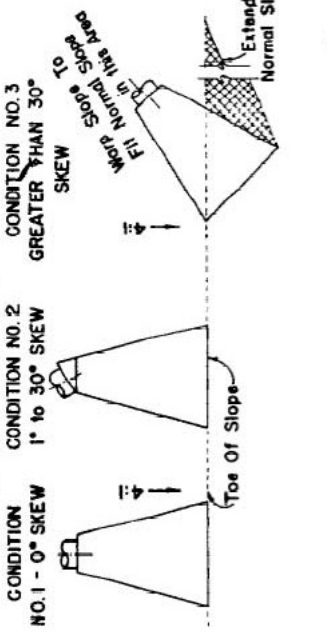

PLAN

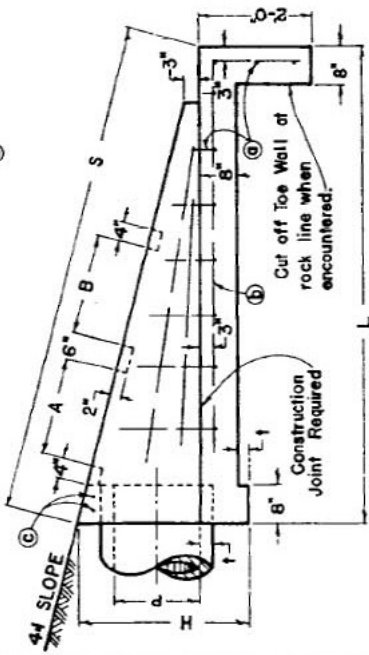

ELEVATION

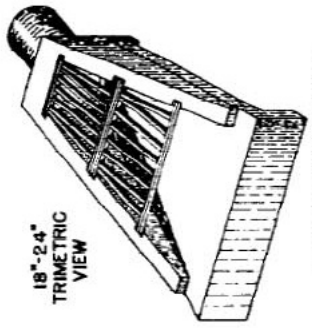

18°-24° TRIMETRIC VIEW

DETAIL SHOWING LOCATION OF SLOTS FOR GRATES

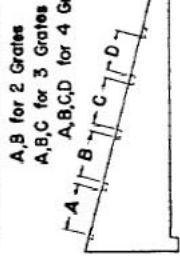

NOTES

- The bid item shall be:
 - (*) S and F Box Inlet-Outlet
 - Size of Pipe
- The minimum requirement for reinforcing steel shall be grade 40. Field bending will be permitted.
- One additional c bar will be required for each 15° skew.
- See Current Edition of RDB-106.

Capacity inlet shall be 2 times pipe discharge diameter at same maximum headwater depth

DIMENSIONS

P	H	L	S	R	V	W	A	B	C	D
18"	3'-0"	8'-6"	8'-9"	2'-6"	3'-5"	6'-10"	1'-9"	1'-9"	—	—
24"	3'-7"	10'-8"	11'-0"	3'-0"	4'-2 1/2"	8'-5"	2'-9"	2'-9"	—	—
30"	4'-2"	12'-10"	13'-2 1/4"	3'-6"	5'-0"	10'-0"	2'-9"	2'-9"	1'-9"	—
36"	4'-9"	15'-0"	15'-5 1/2"	4'-0"	5'-9 1/2"	11'-7"	2'-9"	2'-9"	1'-9"	1'-9"

NO. OF GRATES RECD	NO. 4 REINFORCEMENT BARS				LBS. WTD.
	①	②	③	④	
2	14 at 6'-0"	3 at 8'-6"	2 at 2'-3"	76	1.7
2	16 at 7'-6"	3 at 10'-6"	2 at 2'-9"	105	2.5
1	18 at 9'-0"	3 at 12'-9"	2 at 3'-3"	137	3.6
2	20 at 10'-8"	3 at 15'-0"	2 at 3'-9"	17.7	4.8

KENTUCKY
DEPARTMENT OF HIGHWAYS

SLOPED AND FLARED BOX INLET - OUTLET
18" - 24" - 30" - 36"
ALL SKEWS

STANDARD DRAWING No. RDB-105-01

DATE: 1-18-74
BY: [Signature]
CHECKED: [Signature]
APPROVED: [Signature]

- NOTES -

The unit price bid for each structure shall include all concrete, structural steel grating, excavation, labor and incidentals, necessary for its construction as detailed on this sheet.
 Size and location of pipe slot be as shown on the plans. Payment for all pipe within the limits of a structure shall be included in the unit price bid for the structure.

Structural Steel Grating shall have the following properties:

- Minimum Yield Strength = 36,000 psi
- Minimum Tensile Strength = 58,000 psi
- Minimum Elongation = 21% in 2"

Structural Steel Grating is to be fabricated from 2"x1" structural steel bars and $\frac{5}{16}$ " fillet welds.

Sloped Box Inlet or Outlet Type I is intended to be used with the following pipe sizes:

- BCCSPA Pipe Arch - (15" Equiv. Round)
- BCCSPA Pipe Arch - (18" Equiv. Round)
- RC Elliptical Pipe - (18" Equiv. Round)

Maximum dimension of any surface inlet/grate opening shall be such that a sphere with a diameter of 8 inches cannot pass through any opening.

Capacity of surface openings shall be minimum 2 times x-Section area of pipe discharge

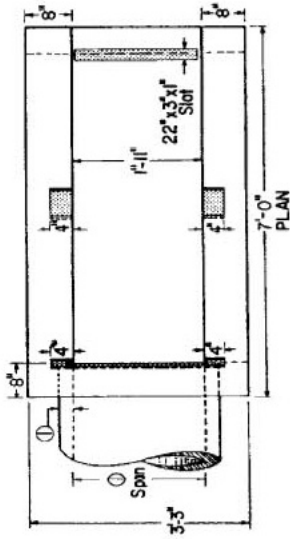

① Variable

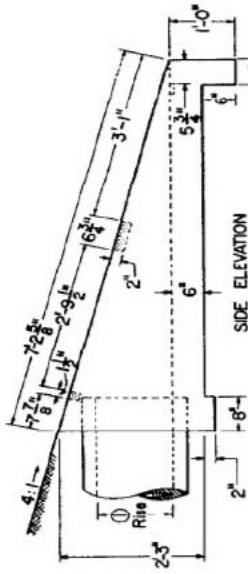

DETAIL OF STRUCTURAL STEEL GRATING

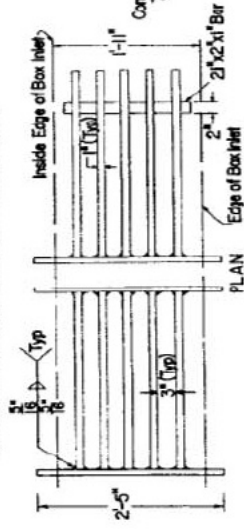

Detail "X" Not to scale

APPROXIMATE QUANTITIES

80 Cu. Yds.
Class A Concrete
Structural Steel Grating No.1 130 Lbs.
Structural Steel Grating No.2 120 Lbs.
Total 250 Lbs.

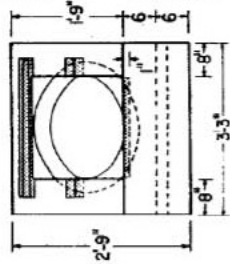

END ELEVATION

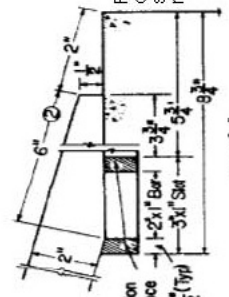

Isometric View - Not to scale

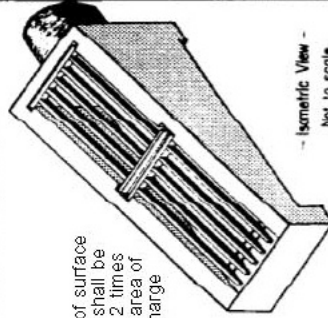

Fitted grates shall be attached via cable or chain cast into concrete with sufficient slack for removal and maintenance

KENTUCKY
 BUREAU OF HIGHWAYS
**SLOPED BOX
 INLET OR OUTLET
 TYPE I**
 STANDARD DRAWING IN 1009-110-02
 APPROVED: [Signature]

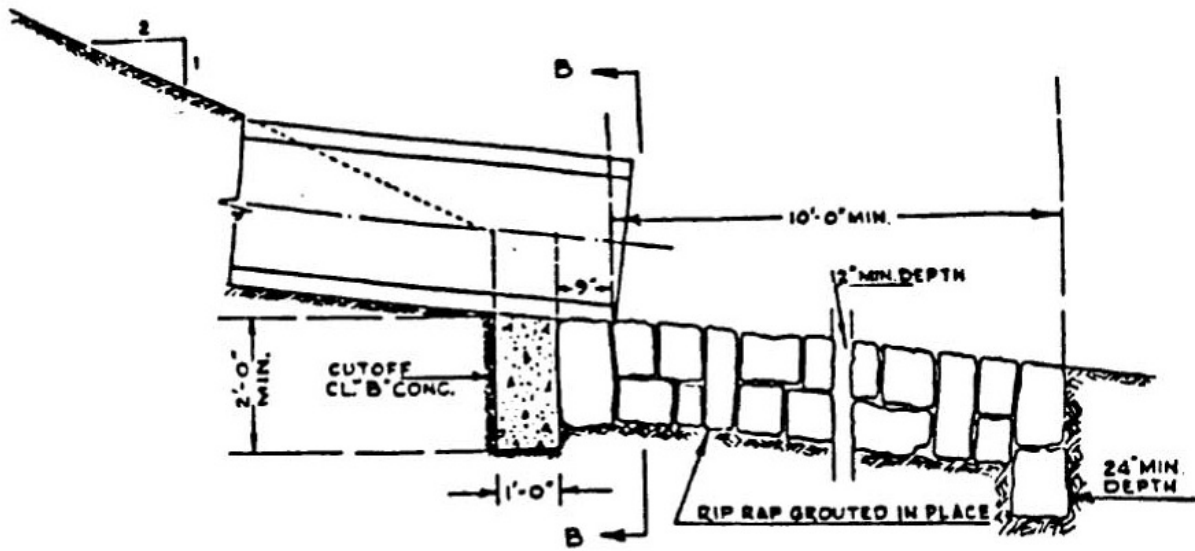

SECTION A-A

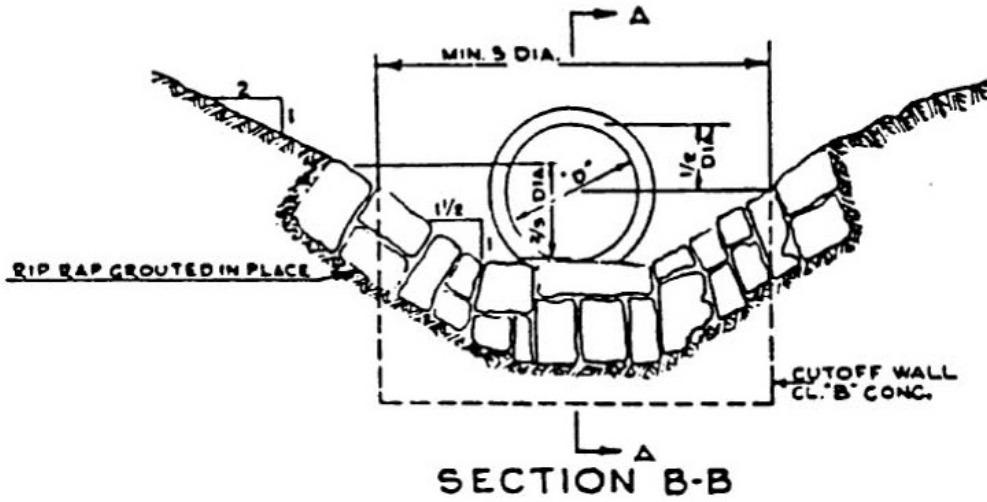

TO BE USED WHERE RIP RAP APRON IS CALLED FOR ON PLANS AND NO DETAIL IS PROVIDED.

RIP RAP APRON AND CUTOFF WALL

SILT CHECK

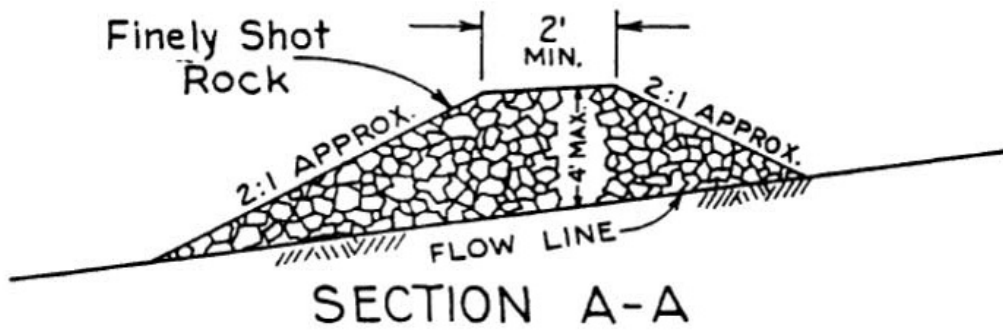
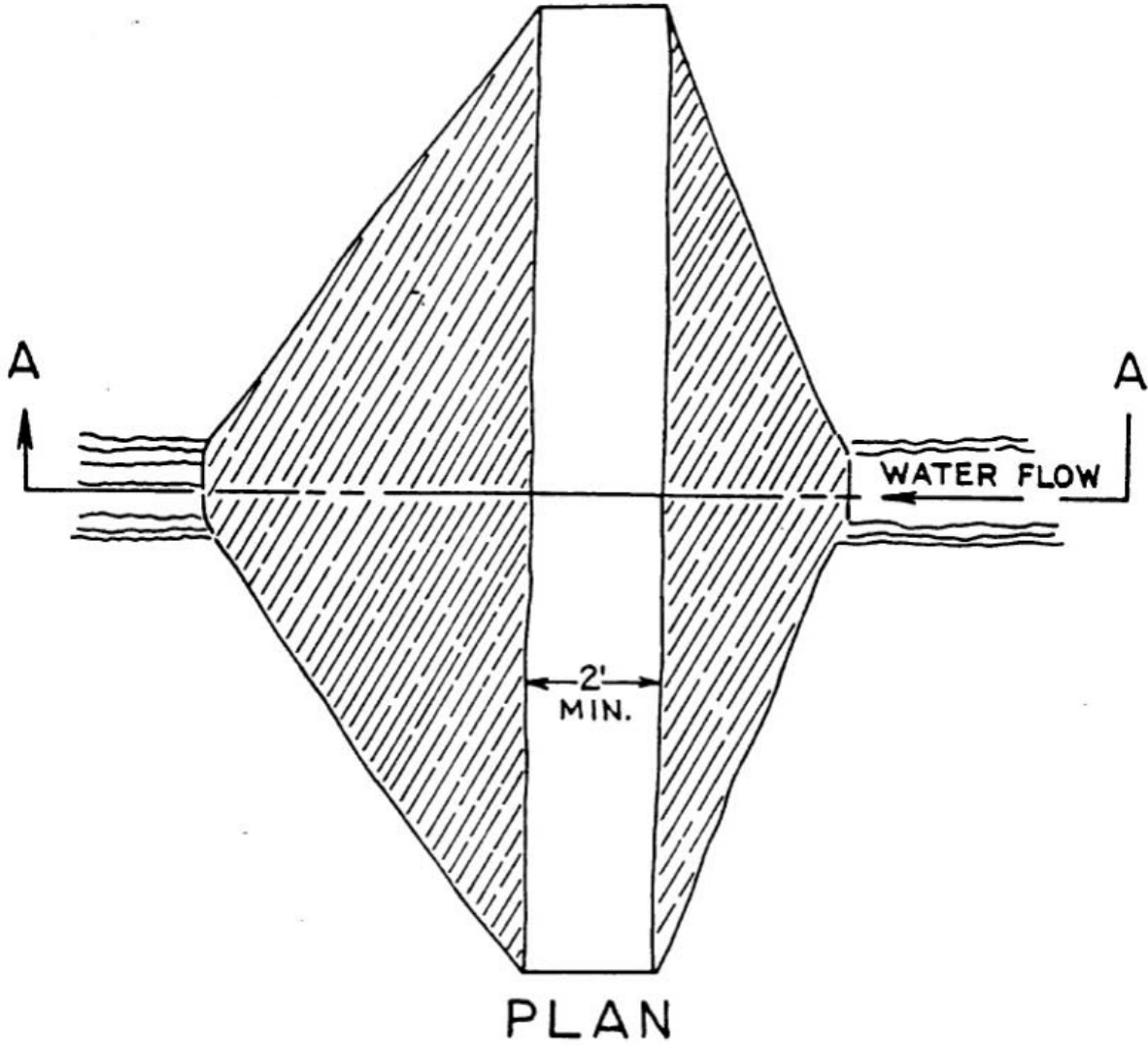

SILT TRAP TYPE A

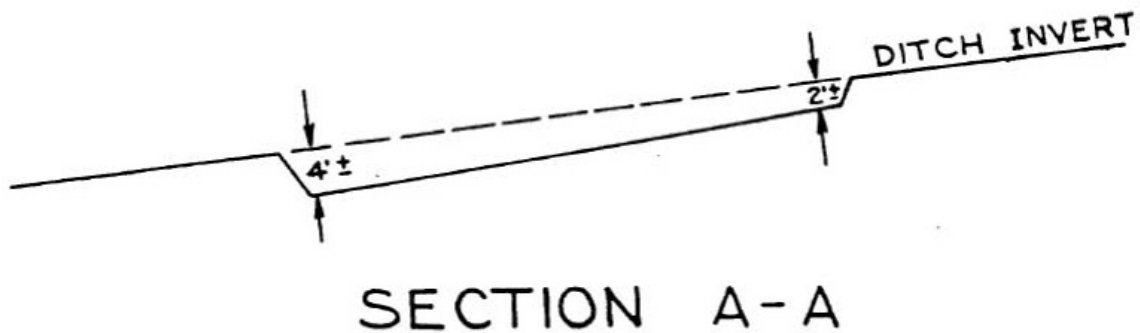
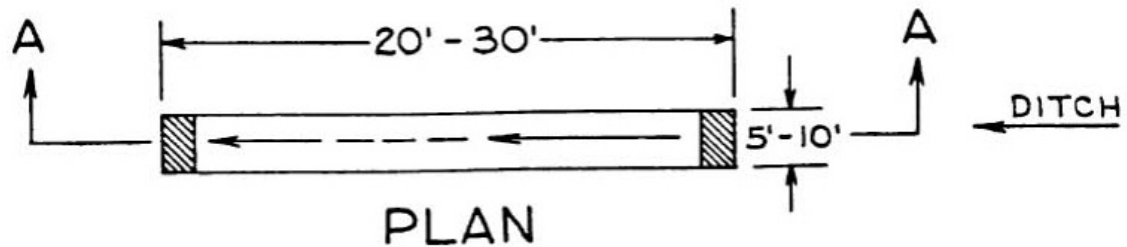

NOTE: SILT TRAP TO BE CLEANED WHEN IT IS APPROXIMATELY 50% FILLED WITH SEDIMENT. SILT TRAPS TO BE PLACED IN SURFACE DRAIN DITCHES AND SIDE DITCHES JUST BEFORE THE WATER (RUNOFF) LEAVES THE RIGHT OF WAY, ENTERS A WATER COURSE, AND AT THE END OF CUT SECTIONS, AND IMMEDIATELY PRECEDING DITCH INLETS. LOCATION OF TRAP AND SIZE (OTHER THAN AS SHOWN) TO BE AS DIRECTED BY THE ENGINEER WHO SHALL REVISE SIDE IF AND AS MAY BE REQUIRED. DIMENSIONS ARE APPROXIMATE.

SILT TRAP TYPE B

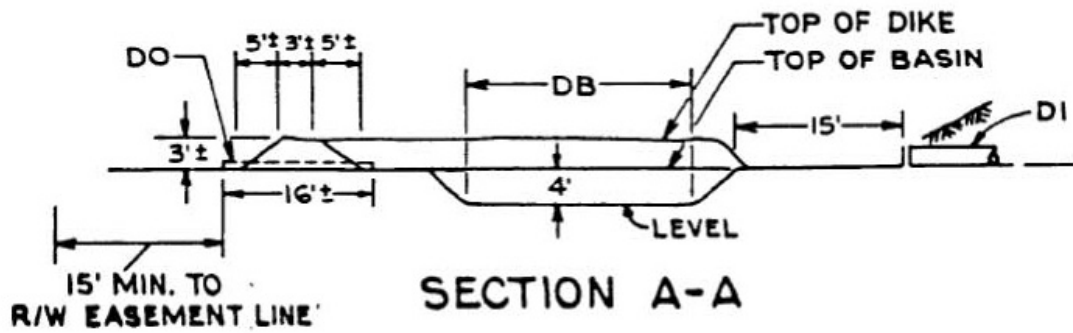
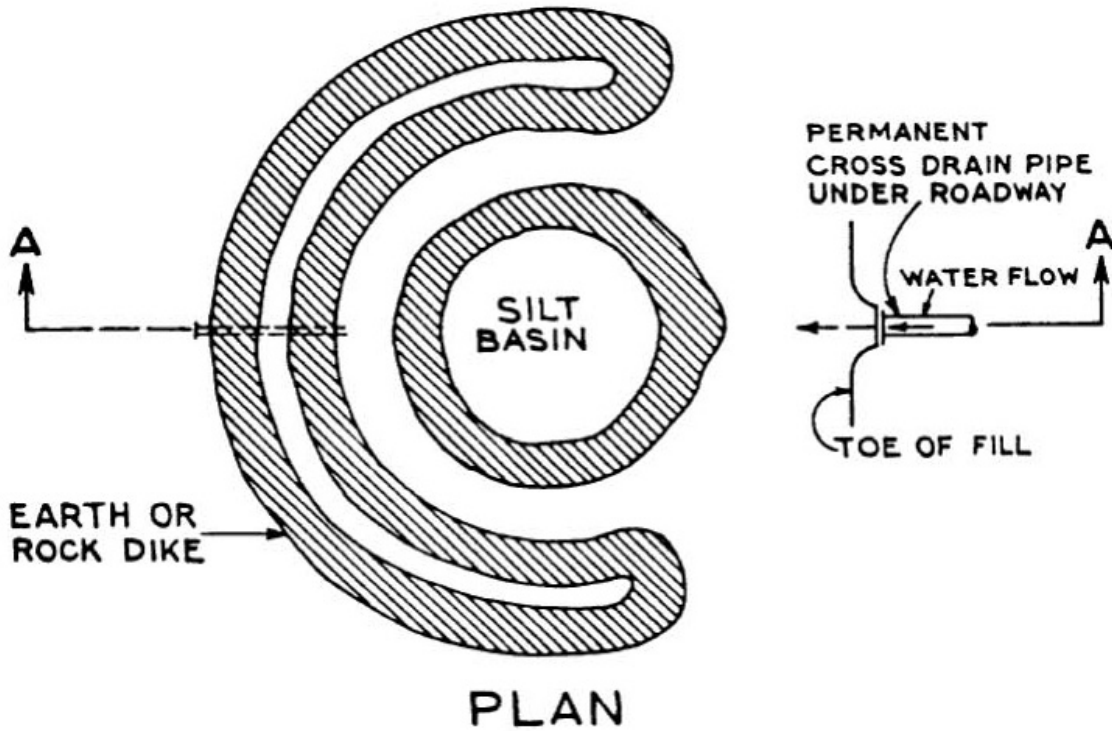

NOTE: ALL DIMENSIONS OF BASIN AND DIKE WILL NOT REQUIRE CONSTRUCTION TO NEAT LINES. THE PLAN VIEW ABOVE INDICATES THE SILT BASIN IS ROUND, HOWEVER, IT IS DRAWN IN THIS MANNER FOR ILLUSTRATION PURPOSES ONLY. THE BASIN MAY BE CONSTRUCTED AS LONG AS THE AREA AND DEPTH OF THE BASIN IS AT LEAST AS LARGE AS INDICATED. DIKES MAY BE CONSTRUCTED OF EARTH OR BROKEN ROCK. EARTH DIKE MUST BE CONSTRUCTED WITH A PIPE AS SHOWN, HOWEVER, BROKEN ROCK DIKES MAY NOT NEED A PIPE.

	DI	DB	DO
SDB	18"	15'	6"
SDB	24"	20'	8"

TYPICAL DETAILS FOR SEDIMENTATION BASIN

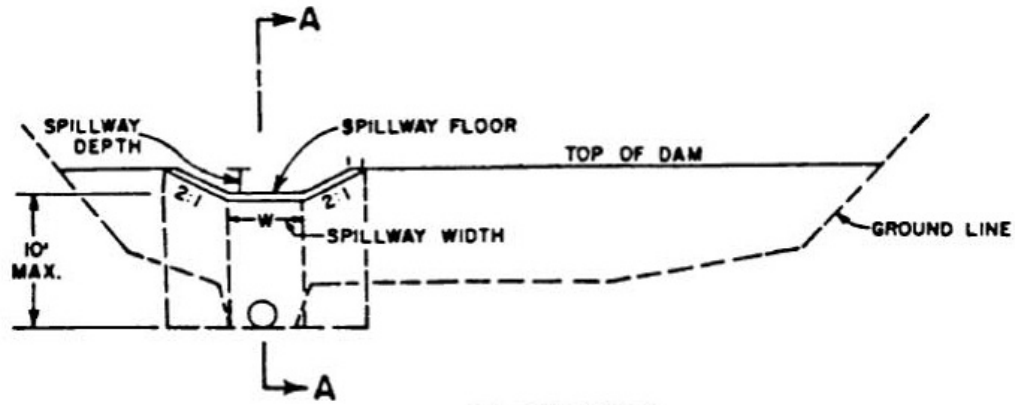

ELEVATION

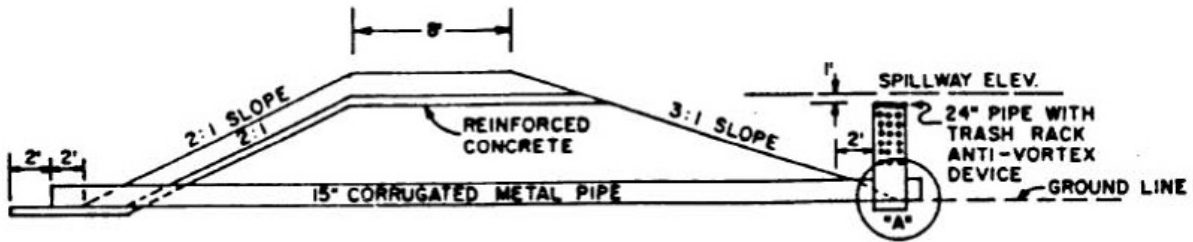

SECTION A-A

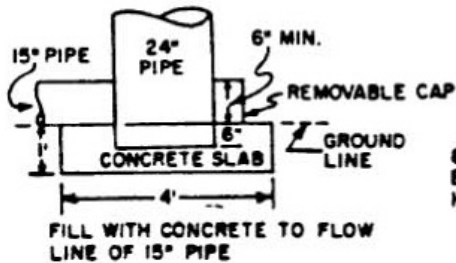

DETAIL "A"

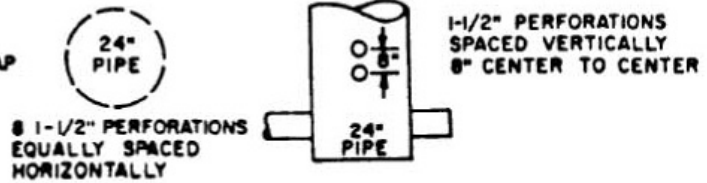

DETAIL SHOWING LOCATION OF PERFORATIONS IN 24" PIPE

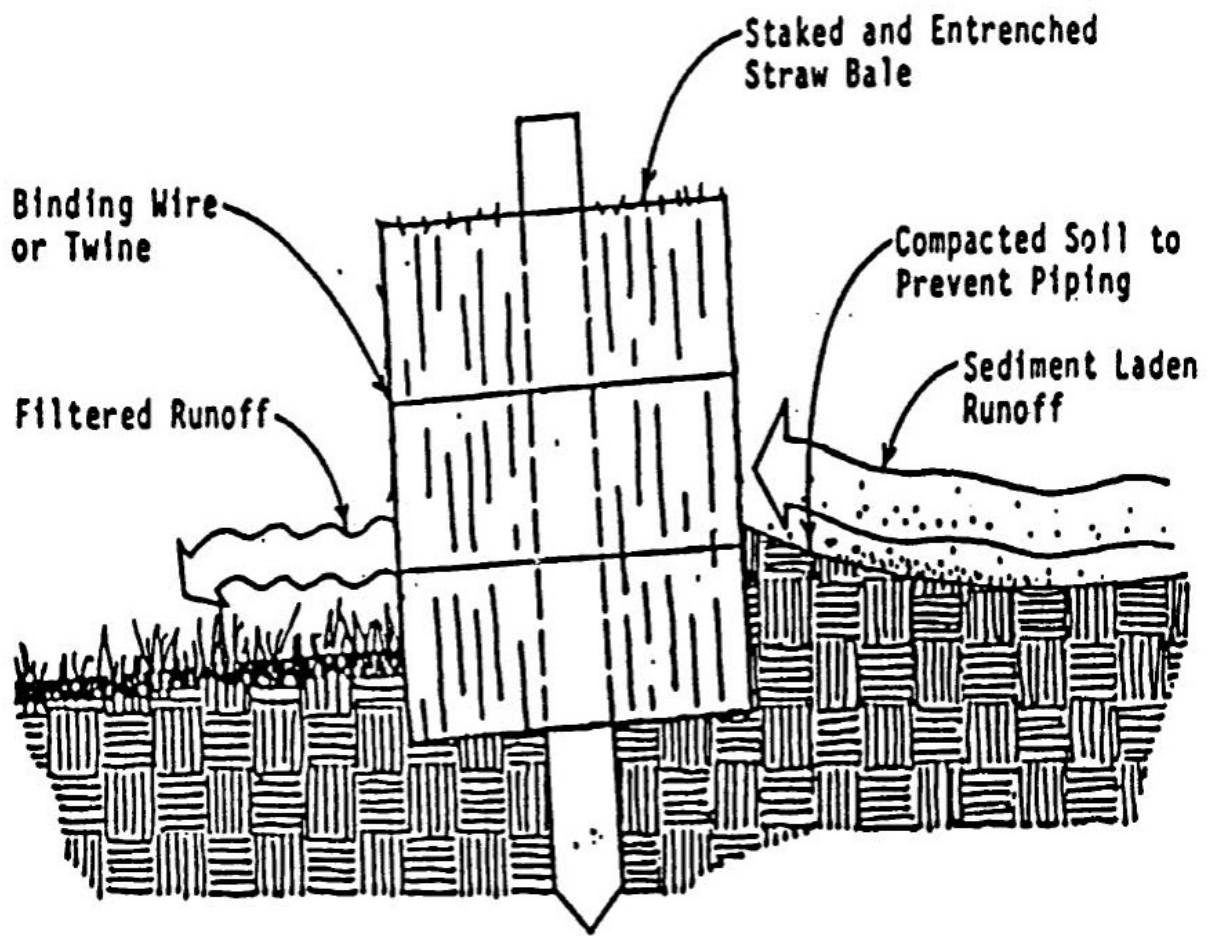

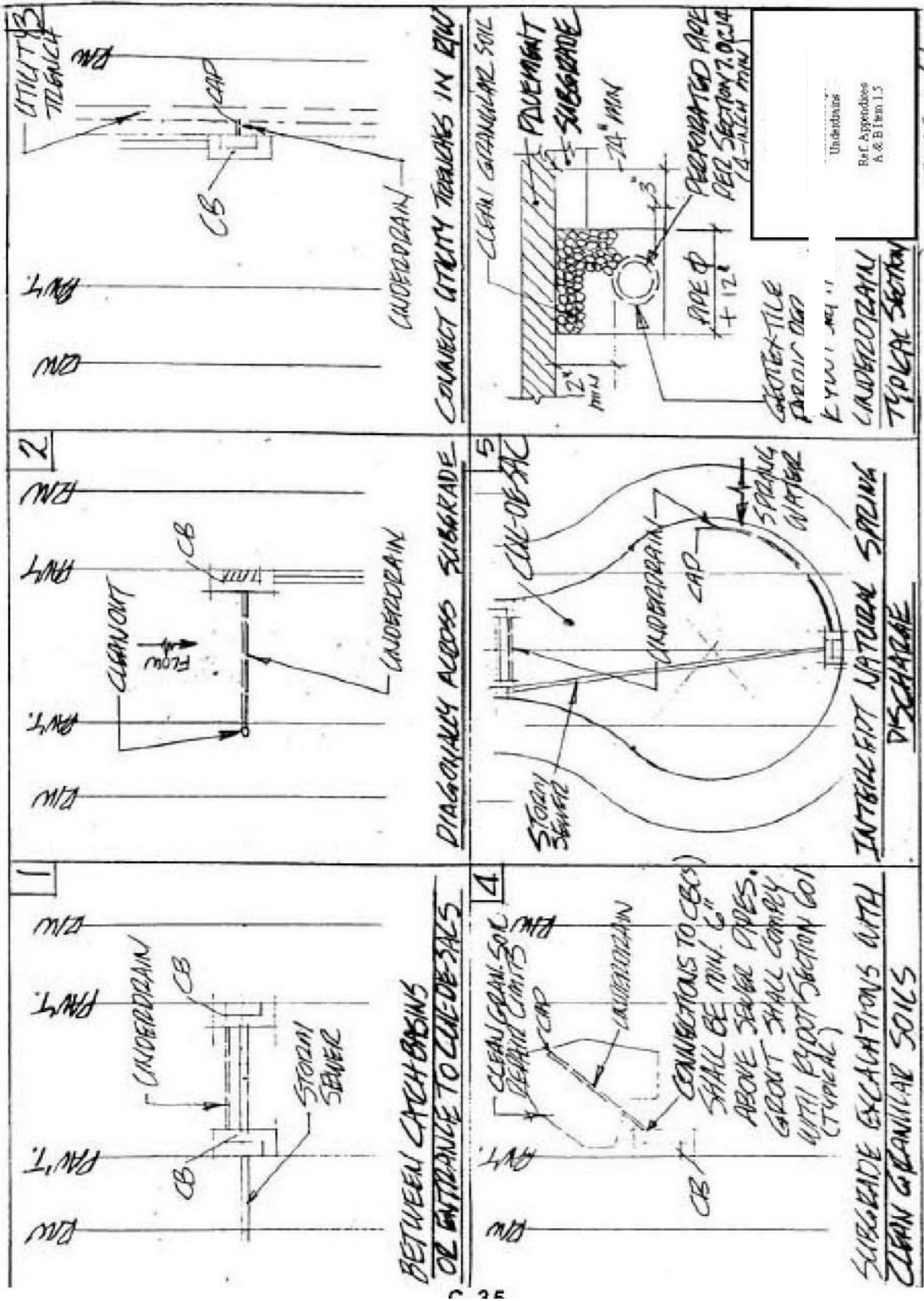

BETWEEN CATCH BASINS
OR ENTRANCE TO CATCH BASINS

DIAGONALLY ACROSS SUBGRADE

CONNECT UTILITY TRENCHES IN RIM

SUBGRADE EXCAVATIONS WITH
CLEAN GRANULAR SOILS

INTERFIT NATURAL SPRING
DISCHARGE

UNDERDRAIN
TYPICAL SECTION

Underdrains
Ref. Appendices
A & B Item 1.5

KY 11 104 11

CONNECTIONS TO CBS
SHALL BE MIN. 6"
ABOVE SEWER PIPES.
GROUT SHALL COMPLY
WITH EY007 SECTION 601
(TYPICAL)

PERFORATED PIPE
PER SECTION 7.02.14
(4-INCH MIN)

CUL-OF-SAC

CLEAN GRANULAR SOIL
PAVEMENT
SUBGRADE
2" MIN
74" MIN
+3"
PERFORATED PIPE
PER SECTION 7.02.14
(4-INCH MIN)
PIPE Ø
+12"

CLEAN GRAN. SOIL
BEHIND CURBS

UNDERDRAIN

CAP

UNDERDRAIN

CB

UNDERDRAIN

UNDERDRAIN

UNDERDRAIN

UNDERDRAIN

UNDERDRAIN

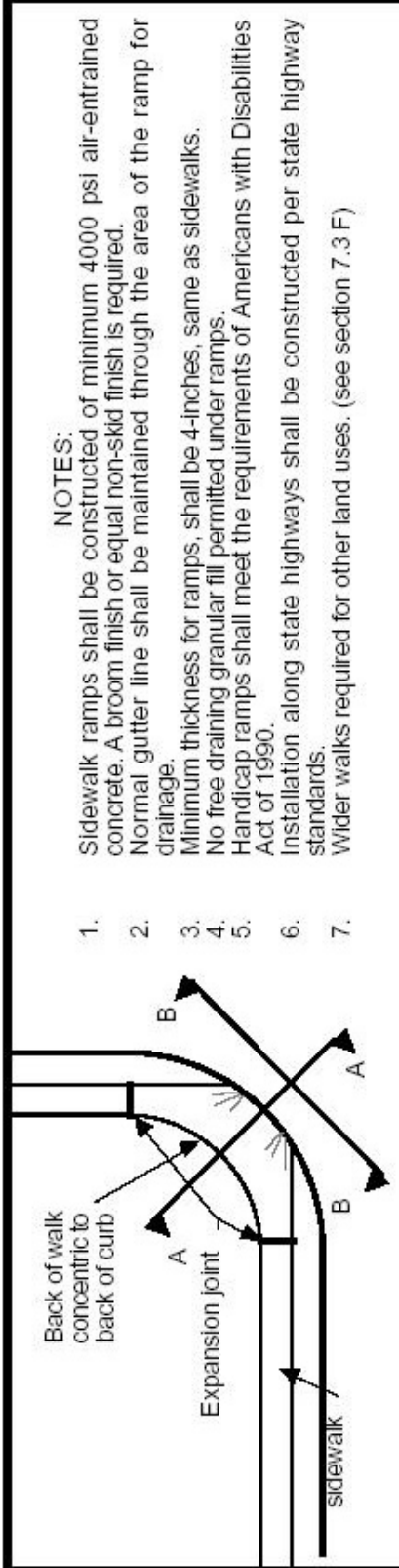

1. Sidewalk ramps shall be constructed of minimum 4000 psi air-entrained concrete. A broom finish or equal non-skid finish is required.
2. Normal gutter line shall be maintained through the area of the ramp for drainage.
3. Minimum thickness for ramps, shall be 4-inches, same as sidewalks.
4. No free draining granular fill permitted under ramps.
5. Handicap ramps shall meet the requirements of Americans with Disabilities Act of 1990.
6. Installation along state highways shall be constructed per state highway standards.
7. Wider walks required for other land uses. (see section 7.3 F)

NOTES:

Plan - Sidewalk Ramp at Intersection

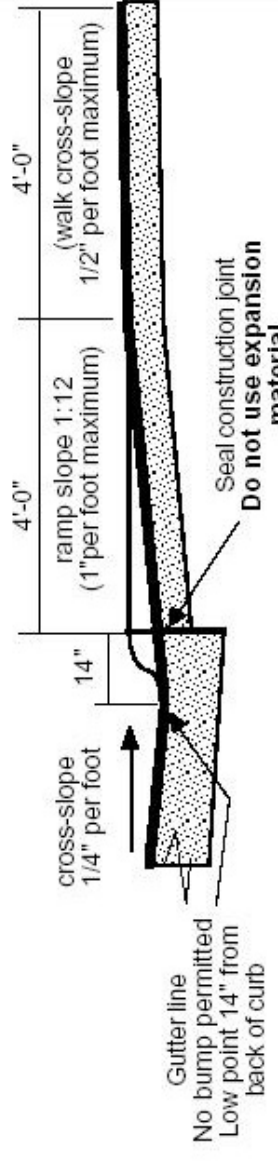

see plan view for placement **Section AA**

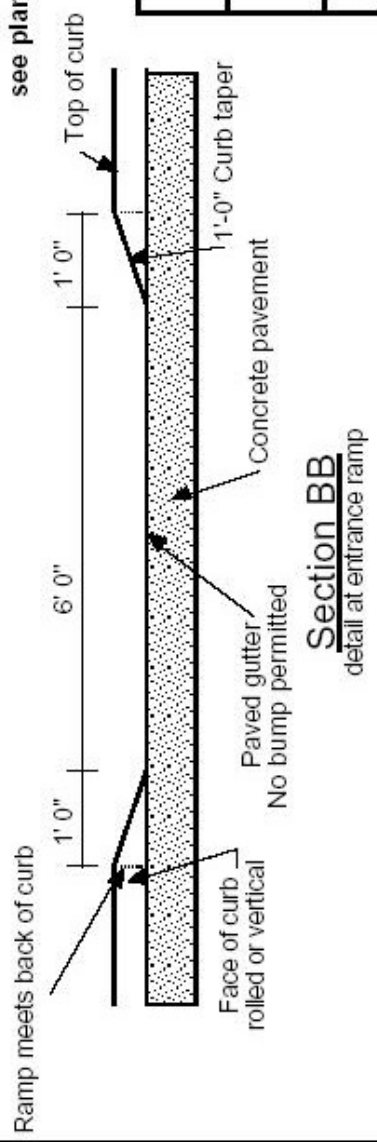

Section BB
detail at entrance ramp

Typical Installation for Sidewalk Ramps